

TLV915x 4.5-MHz, Rail-to-Rail Input/Output, Low Offset Voltage, Low Noise Op Amp

1 Features

- Low offset voltage: $\pm 125 \mu\text{V}$
- Low offset voltage drift: $\pm 0.3 \mu\text{V}/^\circ\text{C}$
- Low noise: $10.5 \text{ nV}/\sqrt{\text{Hz}}$ at 1 kHz
- High common-mode rejection: 120 dB
- Low bias current: $\pm 10 \text{ pA}$
- Rail-to-rail input and output
- Wide bandwidth: 4.5-MHz GBW
- High slew rate: $20 \text{ V}/\mu\text{s}$
- Low quiescent current: $560 \mu\text{A}$ per amplifier
- Wide supply: $\pm 1.35 \text{ V}$ to $\pm 8 \text{ V}$, 2.7 V to 16 V
- Robust EMIRR performance: EMI/RFI filters on input pins
- Differential and common-mode input voltage range to supply rail
- Industry standard packages:
 - Single in SOT-23-5, SOT-23-6, and SC70-5
 - Dual in SOIC-8, SOT-23-8, TSSOP-8, VSSOP-8, WSON-8, and X2QFN-10
 - Quad in SOIC-14, SOT-23-14, TSSOP-14, and X2QFN-14

2 Applications

- [Professional microphones and wireless systems](#)
- [Multiplexed data-acquisition systems](#)
- [Test and measurement equipment](#)
- [Factory automation and control](#)
- [High-side and low-side current sensing](#)

3 Description

The TLV915x family (TLV9151, TLV9152, and TLV9154) is a family of 16-V, general purpose operational amplifiers. These devices offer exceptional DC precision and AC performance, including rail-to-rail output, low offset ($\pm 125 \mu\text{V}$, typical), low offset drift ($\pm 0.3 \mu\text{V}/^\circ\text{C}$, typical), and 4.5-MHz bandwidth.

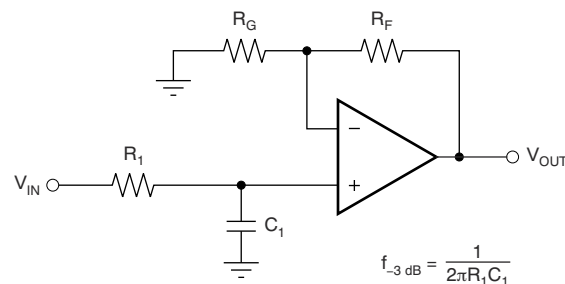
Convenient features such as wide differential input-voltage range, high output current ($\pm 75 \text{ mA}$), high slew rate ($20 \text{ V}/\mu\text{s}$), and low noise ($10.5 \text{ nV}/\sqrt{\text{Hz}}$) make the TLV915x a robust, low-noise operational amplifier for industrial applications.

The TLV915x family of op amps is available in standard packages and is specified from -40°C to 125°C .

Device Information

PART NUMBER ⁽¹⁾	PACKAGE	BODY SIZE (NOM)
TLV9151	SOT-23 (5)	2.90 mm × 1.60 mm
	SOT-23 (6)	2.90 mm × 1.60 mm
	SC70 (5)	2.00 mm × 1.25 mm
TLV9152	SOIC (8)	4.90 mm × 3.90 mm
	SOT-23 (8)	2.90 mm × 1.60 mm
	TSSOP (8)	3.00 mm × 4.40 mm
	VSSOP (8)	3.00 mm × 3.00 mm
	WSON (8)	2.00 mm × 2.00 mm
	X2QFN (10)	1.50 mm × 1.50 mm
TLV9154	SOIC (14)	8.65 mm × 3.90 mm
	SOT-23 (14)	4.20 mm × 1.90 mm
	TSSOP (14)	5.00 mm × 4.40 mm
	X2QFN (14)	2.00 mm × 2.00 mm

(1) For all available packages, see the orderable addendum at the end of the data sheet.



$$\frac{V_{\text{OUT}}}{V_{\text{IN}}} = \left(1 + \frac{R_F}{R_G}\right) \left(\frac{1}{1 + sR_1 C_1}\right)$$

TLV915x in a Single-Pole, Low-Pass Filter



Table of Contents

1 Features	1	7.4 Device Functional Modes.....	30
2 Applications	1	8 Application and Implementation	31
3 Description	1	8.1 Application Information.....	31
4 Revision History	2	8.2 Typical Applications.....	31
5 Pin Configuration and Functions	4	9 Power Supply Recommendations	33
6 Specifications	9	10 Layout	33
6.1 Absolute Maximum Ratings.....	9	10.1 Layout Guidelines.....	33
6.2 ESD Ratings.....	9	10.2 Layout Example.....	34
6.3 Recommended Operating Conditions.....	9	11 Device and Documentation Support	35
6.4 Thermal Information for Single Channel.....	9	11.1 Device Support.....	35
6.5 Thermal Information for Dual Channel.....	10	11.2 Documentation Support.....	35
6.6 Thermal Information for Quad Channel.....	10	11.3 Receiving Notification of Documentation Updates..	35
6.7 Electrical Characteristics.....	11	11.4 Support Resources.....	35
6.8 Typical Characteristics.....	15	11.5 Trademarks.....	36
7 Detailed Description	22	11.6 Electrostatic Discharge Caution.....	36
7.1 Overview.....	22	11.7 Glossary.....	36
7.2 Functional Block Diagram.....	22	12 Mechanical, Packaging, and Orderable Information	37
7.3 Feature Description.....	23		

4 Revision History

NOTE: Page numbers for previous revisions may differ from page numbers in the current version.

Changes from Revision D (May 2021) to Revision E (January 2022)	Page
• Updated industry standard packages in <i>Features</i> to match the packages available in <i>Device Information</i> section	1
• Added SOT-23-14 (DYY) package to <i>Device Information</i>	1
• Added SOT-23-14 (DYY) package and pin functions in <i>Pin Configurations and Functions</i> section.....	4
• Removed WQFN-14 (RTE) package and pin functions in <i>Pin Configurations and Functions</i> section.....	4
• Removed WQFN-16 (RTE) package and pin functions in <i>Pin Configurations and Functions</i> section.....	4
• Corrected typo mislabeling the RUC package as having an "Exposed Thermal Pad" in <i>Pin Configurations and Functions</i> section.....	4
• Removed SOT-553 (DRL) package and pin functions from <i>Pin Configurations and Functions</i> section.....	4
• Removed SOT-563 (DRL) package and pin functions from <i>Pin Configurations and Functions</i> section.....	4
• Corrected typo in <i>Recommended Operating Conditions</i> which labeled V_{IH} as amplifier enabled and V_{IL} as amplifier disabled to correctly label V_{IH} as amplifier disabled and V_{IL} as amplifier enabled.....	9
• Added SOT-23-14 (DYY) package in <i>Thermal Information for Quad Channel</i> section.....	10
• Corrected typo mislabeling the RUC package as a "WQFN" package instead of as a "X2QFN" package in <i>Thermal Information for Quad Channel</i> section.....	10
• Removed "TLV9154S" from header of <i>Thermal Information for Quad Channel</i> section.....	10
• Maximum PSRR specification from $V_S = 4\text{ V}$ to 16 V changed from $\pm 1\text{ }\mu\text{V/V}$ to $\pm 1.6\text{ }\mu\text{V/V}$	11
• Maximum PSRR specification from $V_S = 2.7\text{ V}$ to 16 V changed from $\pm 5\text{ }\mu\text{V/V}$ to $\pm 8.64\text{ }\mu\text{V/V}$	11
• Minimum CMRR specification for $V_S = 16\text{ V}$ changed from 109dB to 99dB.....	11
• Corrected typo in I_{QSD} test conditions in <i>Electrical Characteristics</i> table from "SHDN = V-" to "SHDN = V- + 2 V".....	11
• Removed the overbar from the SHDN pin name in the note on t_{off} and t_{on} in the <i>Electrical Characteristics</i> section for consistency.....	11
• Updated Figure <i>EMIRR Testing</i> and Table <i>TLV9151 EMIRR IN+ for Frequencies of Interest in EMI Rejection</i> to match the increased performance from Figure <i>EMIRR (Electromagnetic Interference Rejection Ratio) vs Frequency</i> in <i>Electrical Characteristics</i>	23
• Changed input resistor values in <i>Equivalent Internal ESD Circuitry Relative to a Typical Circuit Application</i> in <i>Electrical Overstress</i> section to more closely resemble device	27
• Removed WQFN (RTE) package from <i>Packages With an Exposed Thermal Pad</i>	29

- Expanded the *Shutdown* section in the *Detailed Description* section to further clarify shutdown operation and corrected the current consumption in shutdown from 20µA to 30µA and the "typical enable time" in the section from 30µs to 8µs to align with the *Electrical Characteristics* section.....29

Changes from Revision C (December 2020) to Revision D (May 2021) Page

- Changed VSSOP (8) package status on *Device Information* from Preview to Active 1
- Removed preview notation on VSSOP-8 (DGK) package in *Pin Configurations and Functions*4
- Removed VSSOP-10 (DGS) package in *Pin Configurations and Functions* 4

Changes from Revision B (May 2020) to Revision C (December 2020) Page

- Updated the numbering format for tables, figures and cross-references throughout the document1
- Changed SOT-23 (5) package status on *Device Information* from Preview to Active 1
- Changed SC70 (5) package status on *Device Information* from Preview to Active 1
- Changed SOT-23 (6) package status on *Device Information* from Preview to Active 1
- Changed SOT-23 (8) package status on *Device Information* from Preview to Active 1
- Changed VSSOP (8) package status on *Device Information* from Preview to Active 1
- Changed SOIC (14) package status on *Device Information* from Preview to Active 1
- Changed TSSOP (14) package status on *Device Information* from Preview to Active 1
- Changed X2QFN (14) package status on *Device Information* from Preview to Active 1
- Removed preview notation on SOT-23-5 (DBV), SC70-5 (DCK) SOT-23-6 (DBV), and SOT-23-8 (DDF) packages in *Pin Configurations and Functions*4
- Removed preview notation on SOIC-14 (D) package in *Pin Configurations and Functions*4
- Removed preview notation on TSSOP-14 (PW) package in *Pin Configurations and Functions* 4
- Removed preview notation on X2QFN-14 (RUC) package in *Pin Configurations and Functions* 4

Changes from Revision A (March 2020) to Revision B (May 2020) Page

- Changed X2QFN (10) package status on *Device Information* from Preview to Active 1
- Removed preview notation on X2QFN (RUG) package in *Pin Configurations and Functions* 4
- Added V_{IH} and V_{IL} in *Recommended Operating Conditions* section.....9
- Added SHUTDOWN in *Electrical Characteristics* table.....9

Changes from Revision * (October 2019) to Revision A (March 2020) Page

- Changed document status from *Advance Information* to *Production Data*1
- Changed SOIC (8) package status on *Device Information* from Preview to Active 1
- Changed TSSOP (8) package status on *Device Information* from Preview to Active 1
- Changed WSON (8) package status on *Device Information* from Preview to Active 1
- Removed preview notation on SOIC-8 (D), TSSOP-8 (PW), and WSON-8 (DSG) packages in *Pin Configurations and Functions* 4
- Added *Typical Characteristics* section in *Specifications* section.....15

5 Pin Configuration and Functions



**Figure 5-1. TLV9151 DBV Package
5-Pin SOT-23
(Top View)**



**Figure 5-2. TLV9151 DCK
5-Pin SC70
(Top View)**

Table 5-1. Pin Functions: TLV9151

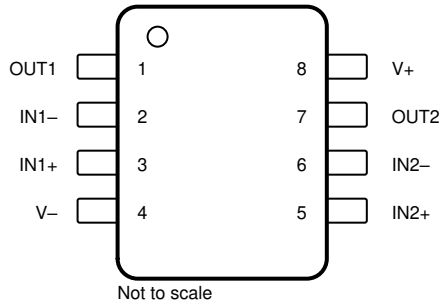
NAME	PIN		I/O	DESCRIPTION
	DBV	DCK		
+IN	3	1	I	Noninverting input
-IN	4	3	I	Inverting input
OUT	1	4	O	Output
V+	5	5	—	Positive (highest) power supply
V-	2	2	—	Negative (lowest) power supply



**Figure 5-3. TLV9151S DBV Package
6-Pin SOT-23
(Top View)**

Table 5-2. Pin Functions: TLV9151S

PIN		I/O	DESCRIPTION
NAME	NO.		
+IN	3	I	Noninverting input
-IN	4	I	Inverting input
OUT	1	O	Output
SHDN	5	I	Shutdown: low = amplifier enabled, high = amplifier disabled. See Shutdown for more information.
V+	6	—	Positive (highest) power supply
V-	2	—	Negative (lowest) power supply



Not to scale

Figure 5-4. TLV9152 D, DDF, DGK, and PW Package 8-Pin SOIC, SOT-23, TSSOP, and VSSOP (Top View)



Not to scale

A. Connect thermal pad to V-. See [Packages with and Exposed Thermal Pad](#) for more information.

Figure 5-5. TLV9152 DSG Package^(A) 8-Pin WSON With Exposed Thermal Pad (Top View)

Table 5-3. Pin Functions: TLV9152

PIN		I/O	DESCRIPTION
NAME	NO.		
+IN A	3	I	Noninverting input, channel A
+IN B	5	I	Noninverting input, channel B
-IN A	2	I	Inverting input, channel A
-IN B	6	I	Inverting input, channel B
OUT A	1	O	Output, channel A
OUT B	7	O	Output, channel B
V+	8	—	Positive (highest) power supply
V-	4	—	Negative (lowest) power supply



**Figure 5-6. TLV9152S RUG Package
10-Pin X2QFN
(Top View)**

Table 5-4. Pin Functions: TLV9152S

PIN		I/O	DESCRIPTION
NAME	NO.		
+IN A	10	I	Noninverting input, channel A
+IN B	4	I	Noninverting input, channel B
-IN A	9	I	Inverting input, channel A
-IN B	5	I	Inverting input, channel B
OUT A	8	O	Output, channel A
OUT B	6	O	Output, channel B
SHDN1	2	I	Shutdown, channel 1: low = amplifier enabled, high = amplifier disabled. See Shutdown for more information.
SHDN2	3	I	Shutdown, channel 2: low = amplifier enabled, high = amplifier disabled. See Shutdown for more information.
V+	7	—	Positive (highest) power supply
V-	1	—	Negative (lowest) power supply



Not to scale

**Figure 5-7. TLV9154 D, PW, and DYY Packages
14-Pin SOIC, TSSOP, and SOT-23
(Top View)**



Not to scale

**Figure 5-8. TLV9154 RUC Package
14-Pin X2QFN
(Top View)**

Table 5-5. Pin Functions: TLV9154

NAME	PIN		I/O	DESCRIPTION
	SOIC, TSSOP, SOT-23	X2QFN		
IN1+	3	2	I	Noninverting input, channel 1
IN1-	2	1	I	Inverting input, channel 1
IN2+	5	4	I	Noninverting input, channel 2
IN2-	6	5	I	Inverting input, channel 2
IN3+	10	9	I	Noninverting input, channel 3
IN3-	9	8	I	Inverting input, channel 3
IN4+	12	11	I	Noninverting input, channel 4
IN4-	13	12	I	Inverting input, channel 4
NC	—	—	—	Do not connect
OUT1	1	14	O	Output, channel 1
OUT2	7	6	O	Output, channel 2
OUT3	8	7	O	Output, channel 3
OUT4	14	13	O	Output, channel 4
V+	4	3	—	Positive (highest) power supply
V-	11	10	—	Negative (lowest) power supply

6 Specifications

6.1 Absolute Maximum Ratings

over operating ambient temperature range (unless otherwise noted) ⁽¹⁾

		MIN	MAX	UNIT
Supply voltage, $V_S = (V+) - (V-)$		0	20	V
Signal input pins	Common-mode voltage ⁽³⁾	$(V-) - 0.5$	$(V+) + 0.5$	V
	Differential voltage ⁽³⁾		$V_S + 0.2$	V
	Current ⁽³⁾	-10	10	mA
Output short-circuit ⁽²⁾		Continuous		
Operating ambient temperature, T_A		-55	150	°C
Junction temperature, T_J			150	°C
Storage temperature, T_{stg}		-65	150	°C

- (1) Stresses beyond those listed under *Absolute Maximum Ratings* may cause permanent damage to the device. These are stress ratings only, which do not imply functional operation of the device at these or any other conditions beyond those indicated under *Recommended Operating Conditions*. Exposure to absolute-maximum-rated conditions for extended periods may affect device reliability.
- (2) Short-circuit to ground, one amplifier per package.
- (3) Input pins are diode-clamped to the power-supply rails. Input signals that may swing more than 0.5 V beyond the supply rails must be current limited to 10 mA or less.

6.2 ESD Ratings

			VALUE	UNIT
$V_{(ESD)}$	Electrostatic discharge	Human body model (HBM), per ANSI/ESDA/JEDEC JS-001 ⁽¹⁾	±2000	V
		Charged device model (CDM), per JEDEC specification JESD22-C101 ⁽²⁾	±1000	

- (1) JEDEC document JEP155 states that 500-V HBM allows safe manufacturing with a standard ESD control process.
- (2) JEDEC document JEP157 states that 250-V CDM allows safe manufacturing with a standard ESD control process.

6.3 Recommended Operating Conditions

over operating ambient temperature range (unless otherwise noted)

		MIN	MAX	UNIT
V_S	Supply voltage, $(V+) - (V-)$	2.7	16	V
V_I	Input voltage range	$(V-) - 0.1$	$(V+) + 0.1$	V
V_{IH}	High level input voltage at shutdown pin (amplifier disabled)	1.1	$(V+)$	V
V_{IL}	Low level input voltage at shutdown pin (amplifier enabled)	$(V-)$	0.2	V
T_A	Specified temperature	-40	125	°C

6.4 Thermal Information for Single Channel

THERMAL METRIC ⁽¹⁾		TLV9151, TLV9151S			UNIT
		DBV (SOT-23)		DCK (SC70)	
		5 PINS	6 PINS	5 PINS	
$R_{\theta JA}$	Junction-to-ambient thermal resistance	185.7	167.8	202.6	°C/W
$R_{\theta JC(top)}$	Junction-to-case (top) thermal resistance	108.2	107.9	101.5	°C/W
$R_{\theta JB}$	Junction-to-board thermal resistance	54.5	49.7	47.8	°C/W
ψ_{JT}	Junction-to-top characterization parameter	31.2	33.9	18.8	°C/W
ψ_{JB}	Junction-to-board characterization parameter	54.2	49.5	47.4	°C/W
$R_{\theta JC(bot)}$	Junction-to-case (bottom) thermal resistance	N/A	N/A	N/A	°C/W

- (1) For more information about traditional and new thermal metrics, see the *Semiconductor and IC Package Thermal Metrics* application report, [SPRA953](#).

6.5 Thermal Information for Dual Channel

THERMAL METRIC ⁽¹⁾		TLV9152, TLV9152S						UNIT
		D (SOIC)	DDF (SOT-23)	DGK (VSSOP)	DSG (WSON)	PW (TSSOP)	RUG (X2QFN)	
		8 PINS	8 PINS	8 PINS	8 PINS	8 PINS	10 PINS	
R _{θJA}	Junction-to-ambient thermal resistance	138.7	143.5	176.5	77.6	185.1	142.3	°C/W
R _{θJC(top)}	Junction-to-case (top) thermal resistance	78.7	79.9	68.1	93.7	74.0	53.5	°C/W
R _{θJB}	Junction-to-board thermal resistance	82.2	61.6	98.2	43.9	115.7	68.5	°C/W
ψ _{JT}	Junction-to-top characterization parameter	27.8	5.7	12.0	4.4	12.3	1.0	°C/W
ψ _{JB}	Junction-to-board characterization parameter	81.4	61.3	96.7	43.9	114.0	68.4	°C/W
R _{θJC(bot)}	Junction-to-case (bottom) thermal resistance	N/A	N/A	N/A	19.0	N/A	N/A	°C/W

(1) For more information about traditional and new thermal metrics, see the *Semiconductor and IC Package Thermal Metrics* application report, [SPRA953](#).

6.6 Thermal Information for Quad Channel

THERMAL METRIC ⁽¹⁾		TLV9154				UNIT
		D (SOIC)	DYY (SOT-23)	PW (TSSOP)	RUC (X2QFN)	
		14 PINS	14 PINS	14 PINS	14 PINS	
R _{θJA}	Junction-to-ambient thermal resistance	101.4	110.6	131.4	125.9	°C/W
R _{θJC(top)}	Junction-to-case (top) thermal resistance	57.6	53.7	51.8	39.8	°C/W
R _{θJB}	Junction-to-board thermal resistance	57.3	35.3	75.8	68.0	°C/W
ψ _{JT}	Junction-to-top characterization parameter	18.5	2.2	7.9	0.8	°C/W
ψ _{JB}	Junction-to-board characterization parameter	56.9	35.0	74.8	67.8	°C/W
R _{θJC(bot)}	Junction-to-case (bottom) thermal resistance	N/A	N/A	N/A	N/A	°C/W

(1) For more information about traditional and new thermal metrics, see the *Semiconductor and IC Package Thermal Metrics* application report, [SPRA953](#).

6.7 Electrical Characteristics

For $V_S = (V+) - (V-) = 2.7\text{ V to }16\text{ V}$ ($\pm 1.35\text{ V to } \pm 8\text{ V}$) at $T_A = 25^\circ\text{C}$, $R_L = 10\text{ k}\Omega$ connected to $V_S / 2$, $V_{CM} = V_S / 2$, and $V_{OUT} = V_S / 2$, unless otherwise noted.

PARAMETER		TEST CONDITIONS		MIN	TYP	MAX	UNIT
OFFSET VOLTAGE							
V_{OS}	Input offset voltage	TLV9151, TLV9152 $V_{CM} = V-$	$T_A = -40^\circ\text{C to }125^\circ\text{C}$		± 125	± 750	μV
		TLV9154 $V_{CM} = V-$			± 125	± 830	
dV_{OS}/dT	Input offset voltage drift		$T_A = -40^\circ\text{C to }125^\circ\text{C}$		± 0.3		$\mu\text{V}/^\circ\text{C}$
PSRR	Input offset voltage versus power supply	$V_{CM} = V-, V_S = 4\text{ V to }16\text{ V}$	$T_A = -40^\circ\text{C to }125^\circ\text{C}$		± 0.3	± 1.6	$\mu\text{V/V}$
		$V_{CM} = V-, V_S = 2.7\text{ V to }16\text{ V}^{(2)}$			± 1	± 8.64	
	Channel separation	$f = 0\text{ Hz}$			5		$\mu\text{V/V}$
INPUT BIAS CURRENT							
I_B	Input bias current				± 10		pA
I_{OS}	Input offset current				± 10		pA
NOISE							
E_N	Input voltage noise	$f = 0.1\text{ Hz to }10\text{ Hz}$			1.8		μV_{PP}
					0.3		μV_{RMS}
e_N	Input voltage noise density	$f = 1\text{ kHz}$			10.8		$\text{nV}/\sqrt{\text{Hz}}$
		$f = 10\text{ kHz}$			9.4		
i_N	Input current noise	$f = 1\text{ kHz}$			2		$\text{fA}/\sqrt{\text{Hz}}$
INPUT VOLTAGE RANGE							
V_{CM}	Common-mode voltage range			$(V-) - 0.1$		$(V+) + 0.1$	V
CMRR	Common-mode rejection ratio	$V_S = 16\text{ V}, (V-) - 0.1\text{ V} < V_{CM} < (V+) - 2\text{ V}$ (Main input pair)	$T_A = -40^\circ\text{C to }125^\circ\text{C}$		99	130	dB
		$V_S = 4\text{ V}, (V-) - 0.1\text{ V} < V_{CM} < (V+) - 2\text{ V}$ (Main input pair)			84	100	
		$V_S = 2.7\text{ V}, (V-) - 0.1\text{ V} < V_{CM} < (V+) - 2\text{ V}$ (Main input pair) ⁽²⁾			75	95	
		$V_S = 2.7\text{ V to }16\text{ V}, (V+) - 1\text{ V} < V_{CM} < (V+) + 0.1\text{ V}$ (Aux input pair)				85	
INPUT CAPACITANCE							
Z_{ID}	Differential				100 3		$\text{M}\Omega \text{pF}$
Z_{ICM}	Common-mode				6 1		$\text{T}\Omega \text{pF}$

6.7 Electrical Characteristics (continued)

For $V_S = (V+) - (V-) = 2.7\text{ V to }16\text{ V}$ ($\pm 1.35\text{ V to } \pm 8\text{ V}$) at $T_A = 25^\circ\text{C}$, $R_L = 10\text{ k}\Omega$ connected to $V_S / 2$, $V_{CM} = V_S / 2$, and $V_{OUT} = V_S / 2$, unless otherwise noted.

PARAMETER		TEST CONDITIONS		MIN	TYP	MAX	UNIT
OPEN-LOOP GAIN							
A_{OL}	Open-loop voltage gain	$V_S = 16\text{ V}$, $V_{CM} = V-$ $(V-) + 0.1\text{ V} < V_O < (V+) - 0.1\text{ V}$	$T_A = -40^\circ\text{C to }125^\circ\text{C}$	120	145		dB
			$T_A = -40^\circ\text{C to }125^\circ\text{C}$		142		
		$V_S = 4\text{ V}$, $V_{CM} = V-$ $(V-) + 0.1\text{ V} < V_O < (V+) - 0.1\text{ V}$	$T_A = -40^\circ\text{C to }125^\circ\text{C}$	104	130	125	
		$V_S = 2.7\text{ V}$, $V_{CM} = V-$ $(V-) + 0.1\text{ V} < V_O < (V+) - 0.1\text{ V}^{(2)}$	$T_A = -40^\circ\text{C to }125^\circ\text{C}$	101	120	118	
FREQUENCY RESPONSE							
GBW	Gain-bandwidth product				4.5		MHz
SR	Slew rate	$V_S = 16\text{ V}$, $G = +1$, $C_L = 20\text{ pF}$			21		V/ μs
t_s	Settling time	To 0.01%, $V_S = 16\text{ V}$, $V_{STEP} = 10\text{ V}$, $G = +1$, $CL = 20\text{ pF}$			2.5		μs
		To 0.01%, $V_S = 16\text{ V}$, $V_{STEP} = 2\text{ V}$, $G = +1$, $CL = 20\text{ pF}$			1.5		
		To 0.1%, $V_S = 16\text{ V}$, $V_{STEP} = 10\text{ V}$, $G = +1$, $CL = 20\text{ pF}$			2		
		To 0.1%, $V_S = 16\text{ V}$, $V_{STEP} = 2\text{ V}$, $G = +1$, $CL = 20\text{ pF}$			1		
	Phase margin	$G = +1$, $R_L = 10\text{ k}\Omega$			60		$^\circ$
	Overload recovery time	$V_{IN} \times \text{gain} > V_S$			400		ns
THD+N	Total harmonic distortion + noise	$V_S = 16\text{ V}$, $V_O = 3\text{ V}_{RMS}$, $G = 1$, $f = 1\text{ kHz}$			0.00021%		
OUTPUT							
	Voltage output swing from rail	Positive and negative rail headroom	$V_S = 16\text{ V}$, $R_L = \text{no load}^{(2)}$		5	10	mV
			$V_S = 16\text{ V}$, $R_L = 10\text{ k}\Omega$		50	55	
			$V_S = 16\text{ V}$, $R_L = 2\text{ k}\Omega$		200	250	
			$V_S = 2.7\text{ V}$, $R_L = \text{no load}^{(2)}$		1	6	
			$V_S = 2.7\text{ V}$, $R_L = 10\text{ k}\Omega$		5	12	
			$V_S = 2.7\text{ V}$, $R_L = 2\text{ k}\Omega$		25	40	
I_{SC}	Short-circuit current				± 75		mA
C_{LOAD}	Capacitive load drive				1000		pF
Z_O	Open-loop output impedance	$f = 1\text{ MHz}$, $I_O = 0\text{ A}$			525		Ω
POWER SUPPLY							
I_Q	Quiescent current per amplifier	$I_O = 0\text{ A}$			560	685	μA
		$I_O = 0\text{ A}$	$T_A = -40^\circ\text{C to }125^\circ\text{C}$			750	

6.7 Electrical Characteristics (continued)

For $V_S = (V+) - (V-) = 2.7\text{ V to }16\text{ V}$ ($\pm 1.35\text{ V to } \pm 8\text{ V}$) at $T_A = 25^\circ\text{C}$, $R_L = 10\text{ k}\Omega$ connected to $V_S / 2$, $V_{CM} = V_S / 2$, and $V_{OUT} = V_S / 2$, unless otherwise noted.

PARAMETER		TEST CONDITIONS	MIN	TYP	MAX	UNIT
SHUTDOWN						
I_{QSD}	Quiescent current per amplifier	$V_S = 2.7\text{ V to }16\text{ V}$, all amplifiers disabled, $SHDN = V- + 2\text{ V}$		30	45	μA
Z_{SHDN}	Output impedance during shutdown	$V_S = 2.7\text{ V to }16\text{ V}$, amplifier disabled		10 2		$\text{G}\Omega \parallel \text{pF}$
V_{IH}	Logic high threshold voltage (amplifier disabled)	For valid input high, the SHDN pin voltage should be greater than the maximum threshold but less than or equal to $V+$		$(V-) + 0.8$	$(V-) + 1.1$	V
V_{IL}	Logic low threshold voltage (amplifier enabled)	For valid input low, the SHDN pin voltage should be less than the minimum threshold but greater than or equal to $V-$	$(V-) + 0.2$	$(V-) + 0.8$		V
t_{ON}	Amplifier enable time ⁽¹⁾	$G = +1$, $V_{CM} = V-$, $V_O = 0.1 \times V_S/2$		8		μs
t_{OFF}	Amplifier disable time ⁽¹⁾	$V_{CM} = V-$, $V_O = V_S/2$		3		μs
	SHDN pin input bias current (per pin)	$V_S = 2.7\text{ V to }16\text{ V}$, $(V+) \geq SHDN \geq (V-) + 0.9\text{ V}$		500		nA
		$V_S = 2.7\text{ V to }16\text{ V}$, $(V-) \leq SHDN \leq (V-) + 0.7\text{ V}$		150		

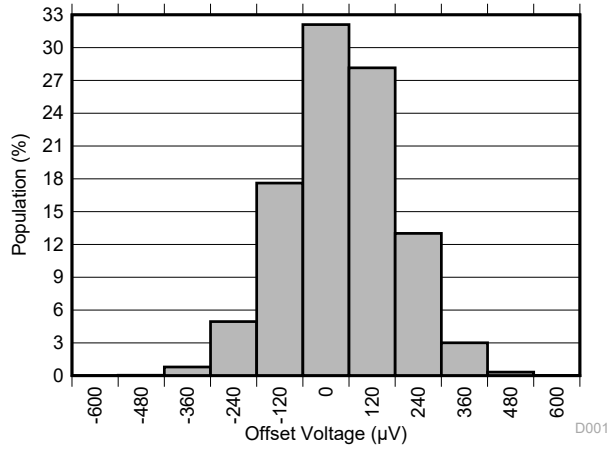
- (1) Disable time (t_{OFF}) and enable time (t_{ON}) are defined as the time interval between the 50% point of the signal applied to the SHDN pin and the point at which the output voltage reaches the 10% (disable) or 90% (enable) level.
- (2) Specified by characterization only.

Table 6-1. Table of Graphs

DESCRIPTION	FIGURE
Offset Voltage Production Distribution	Figure 6-1
Offset Voltage Drift Distribution	Figure 6-2
Offset Voltage vs Temperature	Figure 6-3, Figure 6-4
Offset Voltage vs Common-Mode Voltage	Figure 6-5, Figure 6-6, Figure 6-7, Figure 6-8
Offset Voltage vs Power Supply	Figure 6-9
Open-Loop Gain and Phase vs Frequency	Figure 6-10
Closed-Loop Gain and Phase vs Frequency	Figure 6-11
Input Bias Current vs Common-Mode Voltage	Figure 6-12
Input Bias Current vs Temperature	Figure 6-13
Output Voltage Swing vs Output Current	Figure 6-14, Figure 6-15
CMRR and PSRR vs Frequency	Figure 6-16
CMRR vs Temperature	Figure 6-17
PSRR vs Temperature	Figure 6-18
0.1-Hz to 10-Hz Noise	Figure 6-19
Input Voltage Noise Spectral Density vs Frequency	Figure 6-20
THD+N Ratio vs Frequency	Figure 6-21
THD+N vs Output Amplitude	Figure 6-22
Quiescent Current vs Supply Voltage	Figure 6-23
Quiescent Current vs Temperature	Figure 6-24
Open Loop Voltage Gain vs Temperature	Figure 6-25
Open Loop Output Impedance vs Frequency	Figure 6-26
Small Signal Overshoot vs Capacitive Load (100-mV Output Step)	Figure 6-27, Figure 6-28
Phase Margin vs Capacitive Load	Figure 6-29
No Phase Reversal	Figure 6-30
Positive Overload Recovery	Figure 6-31
Negative Overload Recovery	Figure 6-32
Small-Signal Step Response (100 mV)	Figure 6-33, Figure 6-34
Large-Signal Step Response	Figure 6-35, Figure 6-36, Figure 6-37
Short-Circuit Current vs Temperature	Figure 6-38
Maximum Output Voltage vs Frequency	Figure 6-39
Channel Separation vs Frequency	Figure 6-40
EMIRR vs Frequency	Figure 6-41

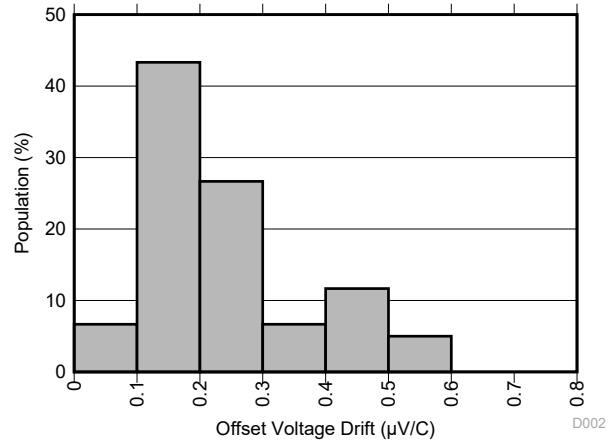
6.8 Typical Characteristics

at $T_A = 25^\circ\text{C}$, $V_S = \pm 8\text{ V}$, $V_{CM} = V_S / 2$, $R_{LOAD} = 10\text{ k}\Omega$ connected to $V_S / 2$, and $C_L = 10\text{ pF}$ (unless otherwise noted)



Distribution from 15462 amplifiers, $T_A = 25^\circ\text{C}$

Figure 6-1. Offset Voltage Production Distribution



Distribution from 60 amplifiers

Figure 6-2. Offset Voltage Drift Distribution

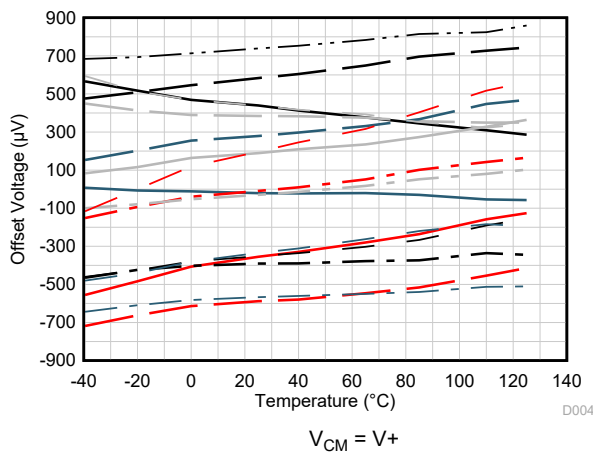


Figure 6-3. Offset Voltage vs Temperature

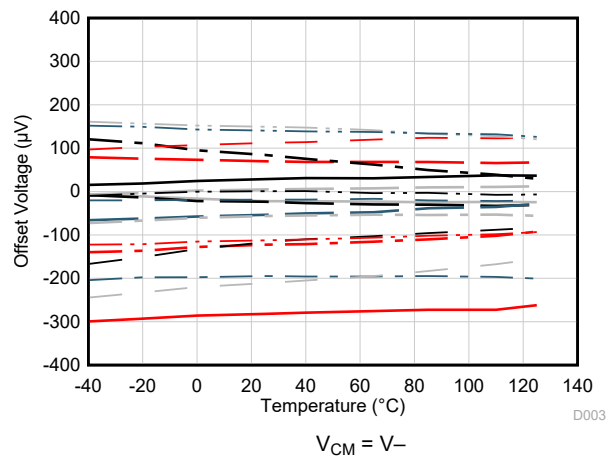


Figure 6-4. Offset Voltage vs Temperature

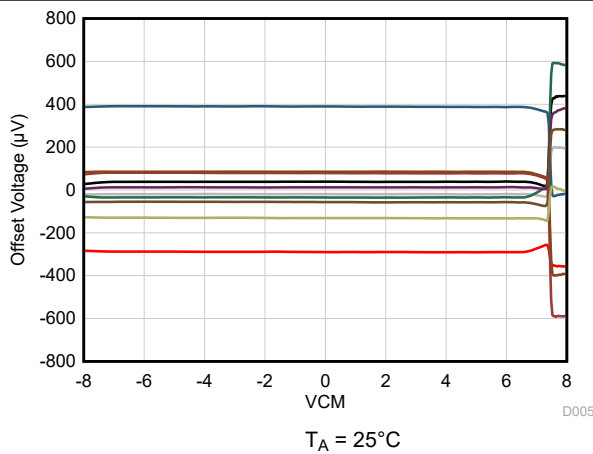


Figure 6-5. Offset Voltage vs Common-Mode Voltage

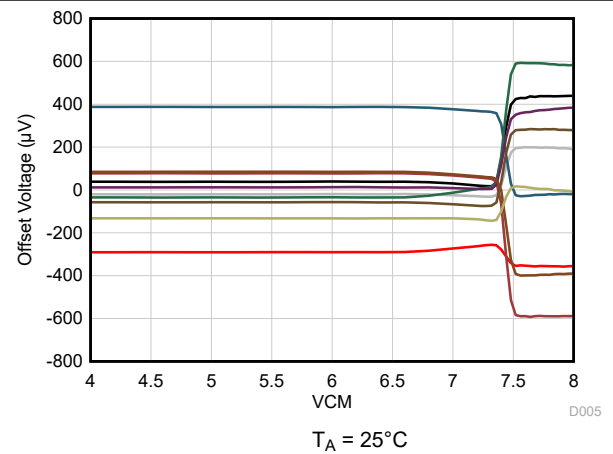


Figure 6-6. Offset Voltage vs Common-Mode Voltage (Transition Region)

6.8 Typical Characteristics (continued)

at $T_A = 25^\circ\text{C}$, $V_S = \pm 8\text{ V}$, $V_{CM} = V_S / 2$, $R_{LOAD} = 10\text{ k}\Omega$ connected to $V_S / 2$, and $C_L = 10\text{ pF}$ (unless otherwise noted)

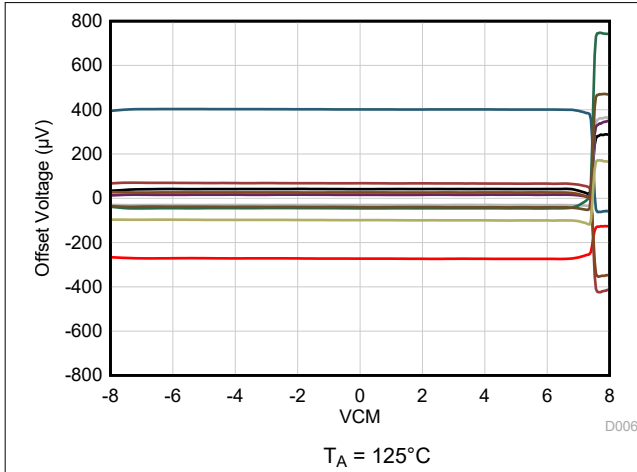


Figure 6-7. Offset Voltage vs Common-Mode Voltage

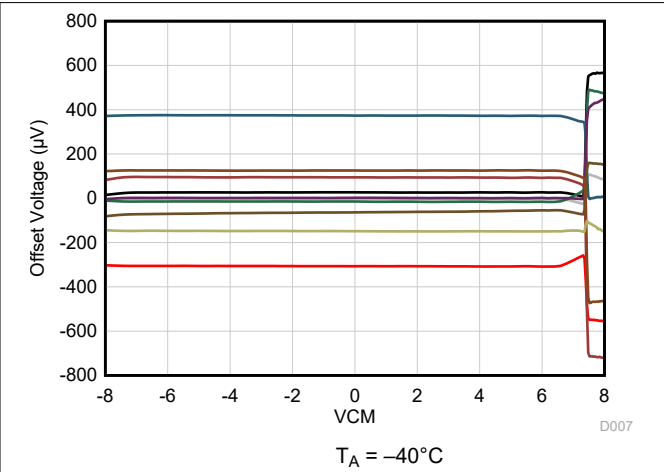


Figure 6-8. Offset Voltage vs Common-Mode Voltage



Figure 6-9. Offset Voltage vs Power Supply

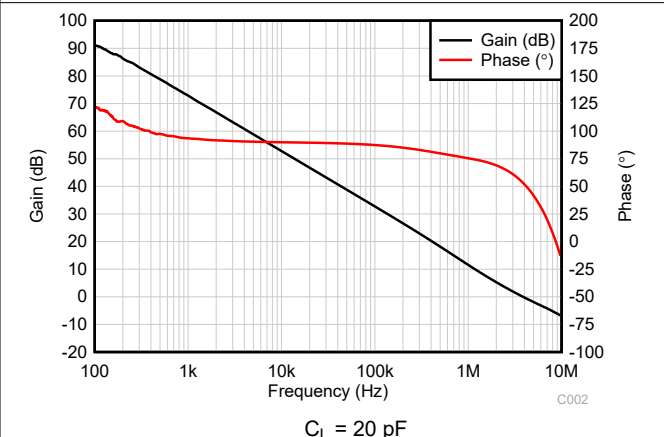


Figure 6-10. Open-Loop Gain and Phase vs Frequency



Figure 6-11. Closed-Loop Gain vs Frequency

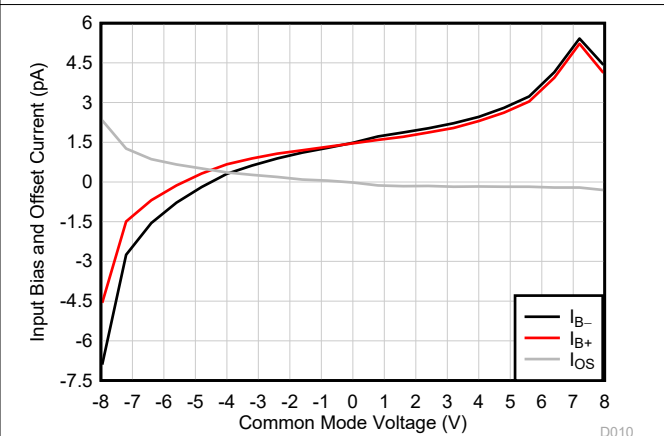


Figure 6-12. Input Bias Current vs Common-Mode Voltage

6.8 Typical Characteristics (continued)

at $T_A = 25^\circ\text{C}$, $V_S = \pm 8\text{ V}$, $V_{CM} = V_S / 2$, $R_{LOAD} = 10\text{ k}\Omega$ connected to $V_S / 2$, and $C_L = 10\text{ pF}$ (unless otherwise noted)

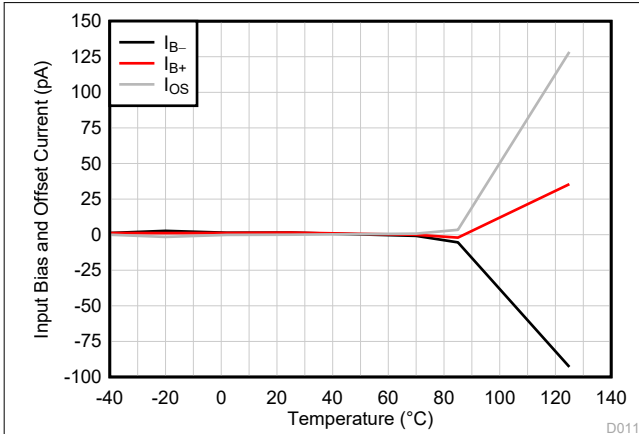


Figure 6-13. Input Bias Current vs Temperature

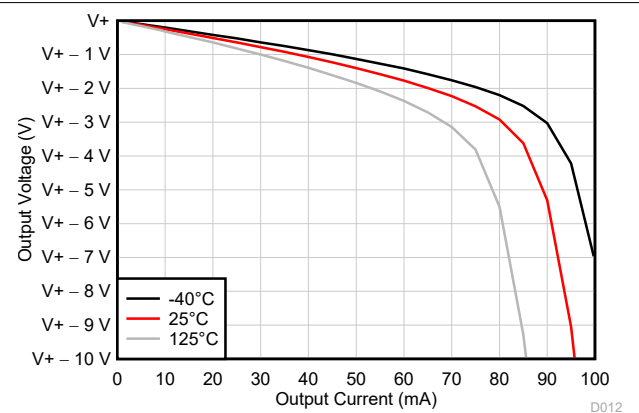


Figure 6-14. Output Voltage Swing vs Output Current (Sourcing)

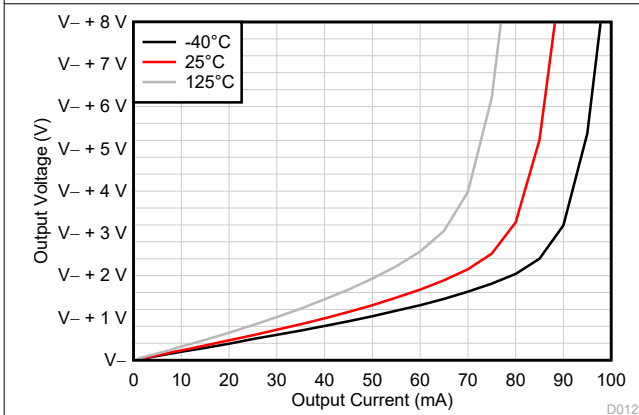


Figure 6-15. Output Voltage Swing vs Output Current (Sinking)

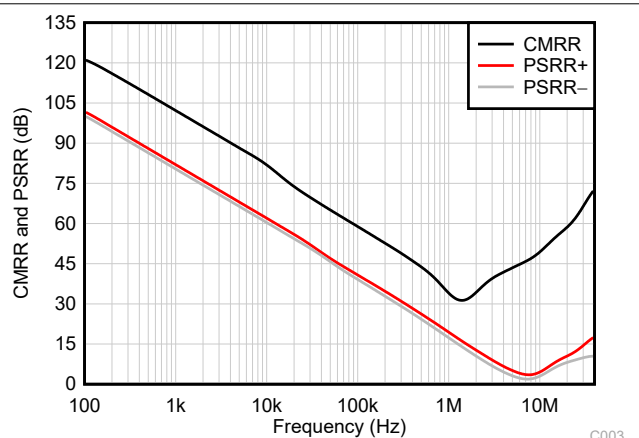


Figure 6-16. CMRR and PSRR vs Frequency

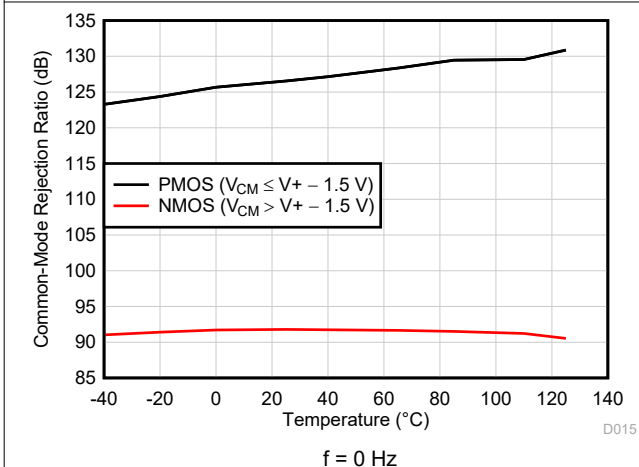


Figure 6-17. CMRR vs Temperature (dB)

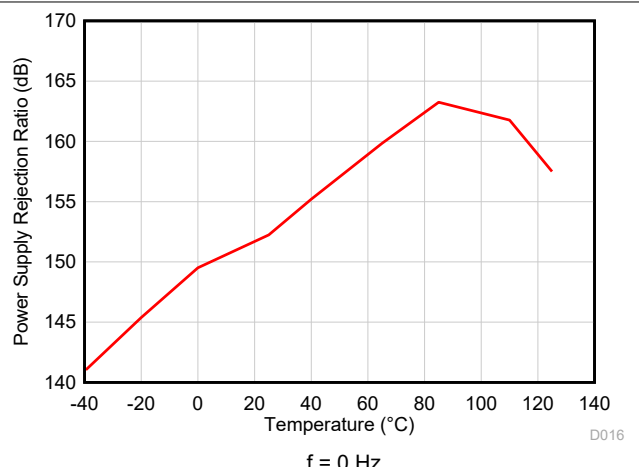


Figure 6-18. PSRR vs Temperature (dB)

6.8 Typical Characteristics (continued)

at $T_A = 25^\circ\text{C}$, $V_S = \pm 8\text{ V}$, $V_{CM} = V_S / 2$, $R_{LOAD} = 10\text{ k}\Omega$ connected to $V_S / 2$, and $C_L = 10\text{ pF}$ (unless otherwise noted)



Figure 6-19. 0.1-Hz to 10-Hz Noise

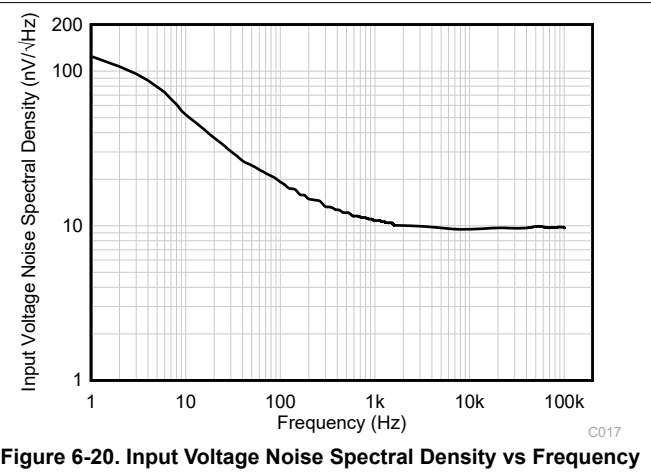


Figure 6-20. Input Voltage Noise Spectral Density vs Frequency

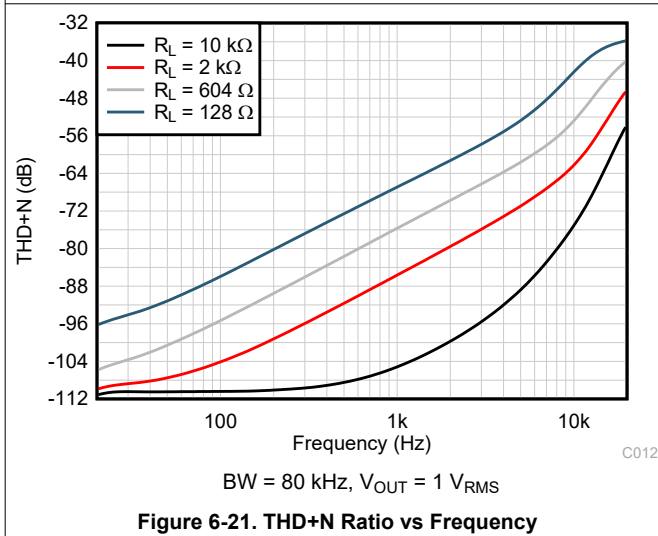


Figure 6-21. THD+N Ratio vs Frequency

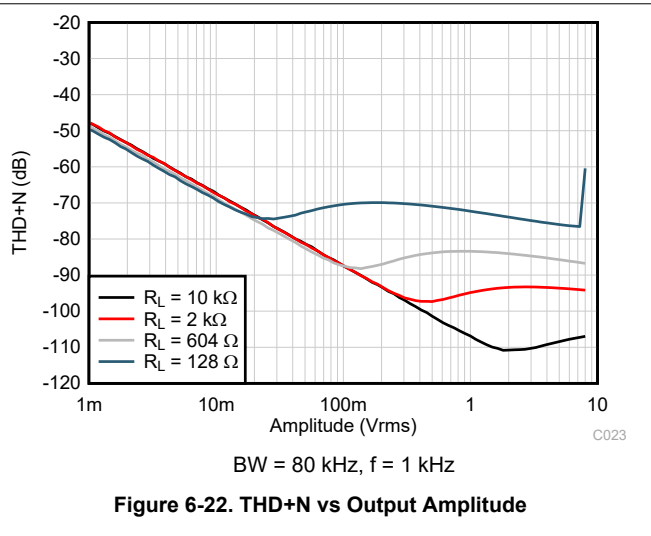


Figure 6-22. THD+N vs Output Amplitude

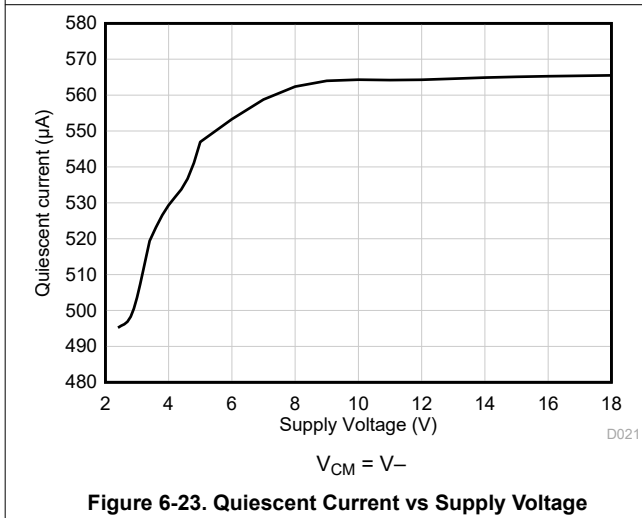


Figure 6-23. Quiescent Current vs Supply Voltage

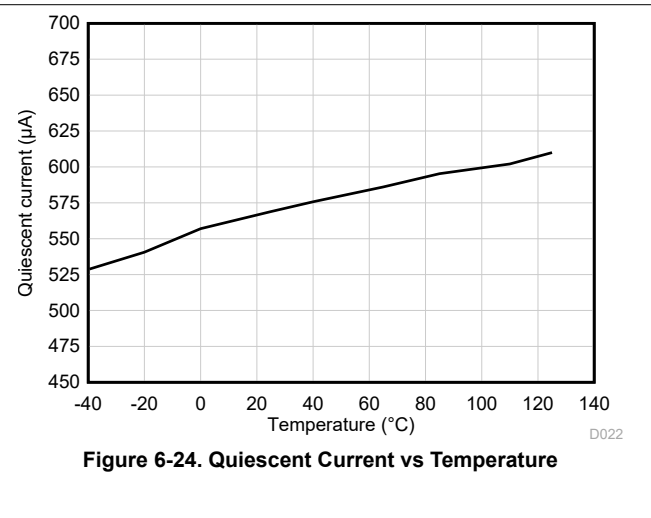


Figure 6-24. Quiescent Current vs Temperature

6.8 Typical Characteristics (continued)

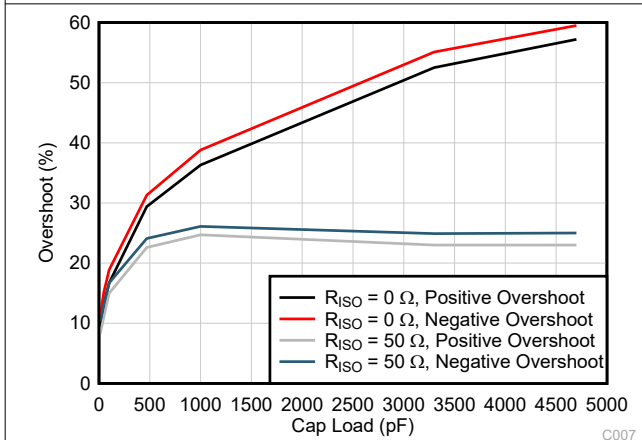
at $T_A = 25^\circ\text{C}$, $V_S = \pm 8\text{ V}$, $V_{CM} = V_S / 2$, $R_{LOAD} = 10\text{ k}\Omega$ connected to $V_S / 2$, and $C_L = 10\text{ pF}$ (unless otherwise noted)



Figure 6-25. Open-Loop Voltage Gain vs Temperature (dB)

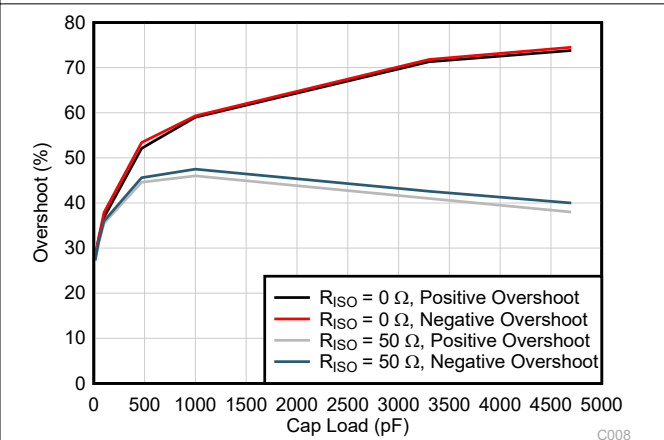


Figure 6-26. Open-Loop Output Impedance vs Frequency



$G = -1$, 10-mV output step

Figure 6-27. Small-Signal Overshoot vs Capacitive Load



$G = 1$, 10-mV output step

Figure 6-28. Small-Signal Overshoot vs Capacitive Load

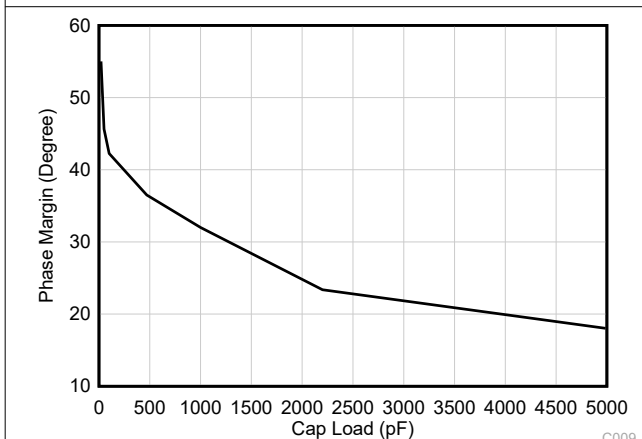
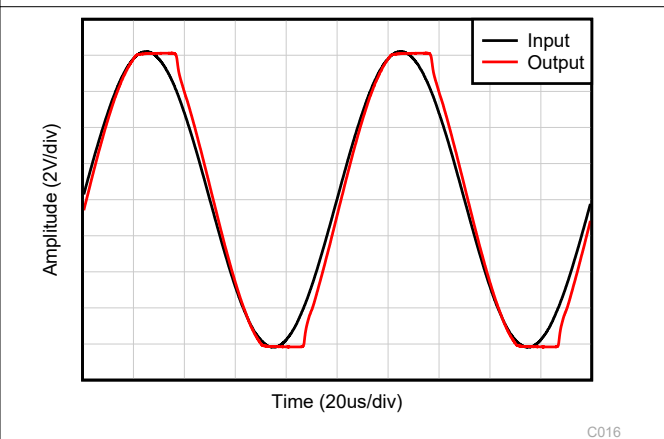


Figure 6-29. Phase Margin vs Capacitive Load



$V_{IN} = \pm 8\text{ V}$; $V_S = V_{OUT} = \pm 17\text{ V}$

Figure 6-30. No Phase Reversal

6.8 Typical Characteristics (continued)

at $T_A = 25^\circ\text{C}$, $V_S = \pm 8\text{ V}$, $V_{CM} = V_S / 2$, $R_{LOAD} = 10\text{ k}\Omega$ connected to $V_S / 2$, and $C_L = 10\text{ pF}$ (unless otherwise noted)



$G = -10$

C018

Figure 6-31. Positive Overload Recovery



$G = -10$

C018

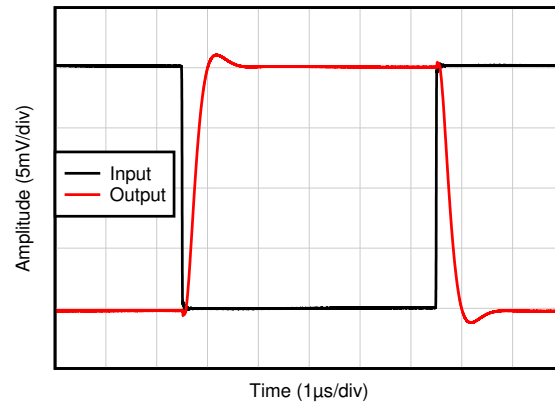
Figure 6-32. Negative Overload Recovery



$C_L = 20\text{ pF}$, $G = 1$, 20-mV step response

C010

Figure 6-33. Small-Signal Step Response, Rising



$C_L = 20\text{ pF}$, $G = 1$, 20-mV step response

C011

Figure 6-34. Small-Signal Step Response, Falling



$C_L = 20\text{ pF}$, $G = 1$

C005

Figure 6-35. Large-Signal Step Response (Rising)



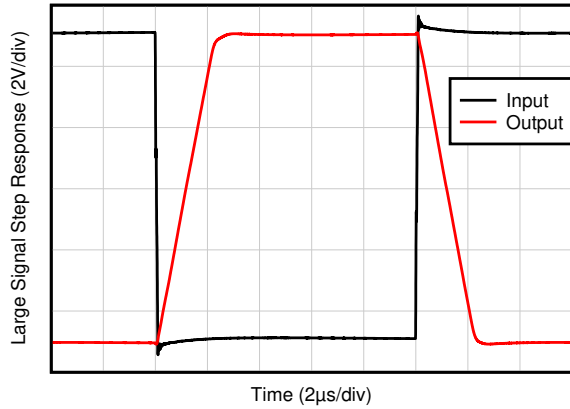
$C_L = 20\text{ pF}$, $G = 1$

C005

Figure 6-36. Large-Signal Step Response (Falling)

6.8 Typical Characteristics (continued)

at $T_A = 25^\circ\text{C}$, $V_S = \pm 8\text{ V}$, $V_{CM} = V_S / 2$, $R_{LOAD} = 10\text{ k}\Omega$ connected to $V_S / 2$, and $C_L = 10\text{ pF}$ (unless otherwise noted)



$C_L = 20\text{ pF}$, $G = -1$

Figure 6-37. Large-Signal Step Response

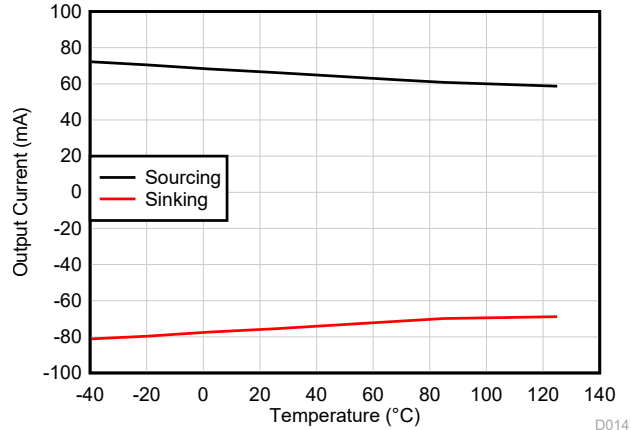


Figure 6-38. Short-Circuit Current vs Temperature

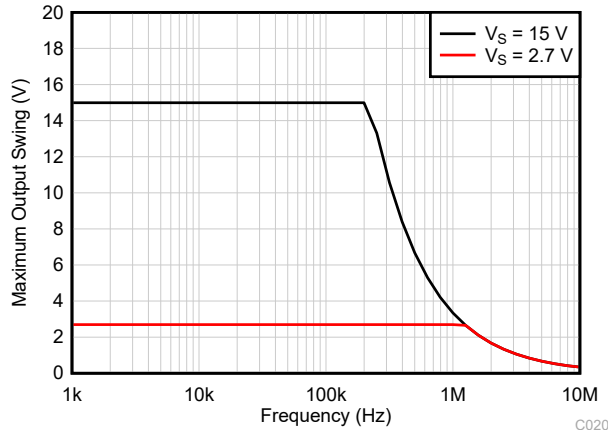


Figure 6-39. Maximum Output Voltage vs Frequency

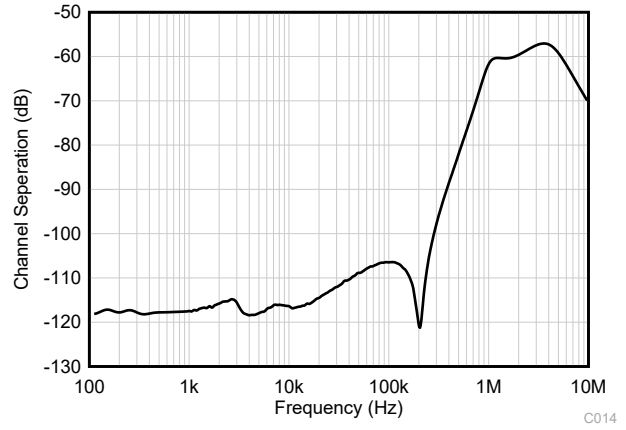


Figure 6-40. Channel Separation vs Frequency

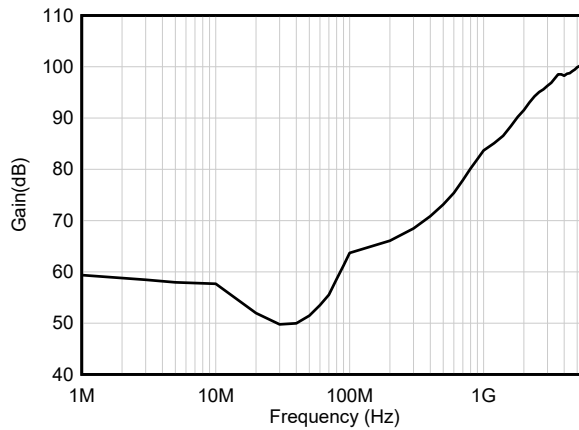


Figure 6-41. EMIRR (Electromagnetic Interference Rejection Ratio) vs Frequency

7 Detailed Description

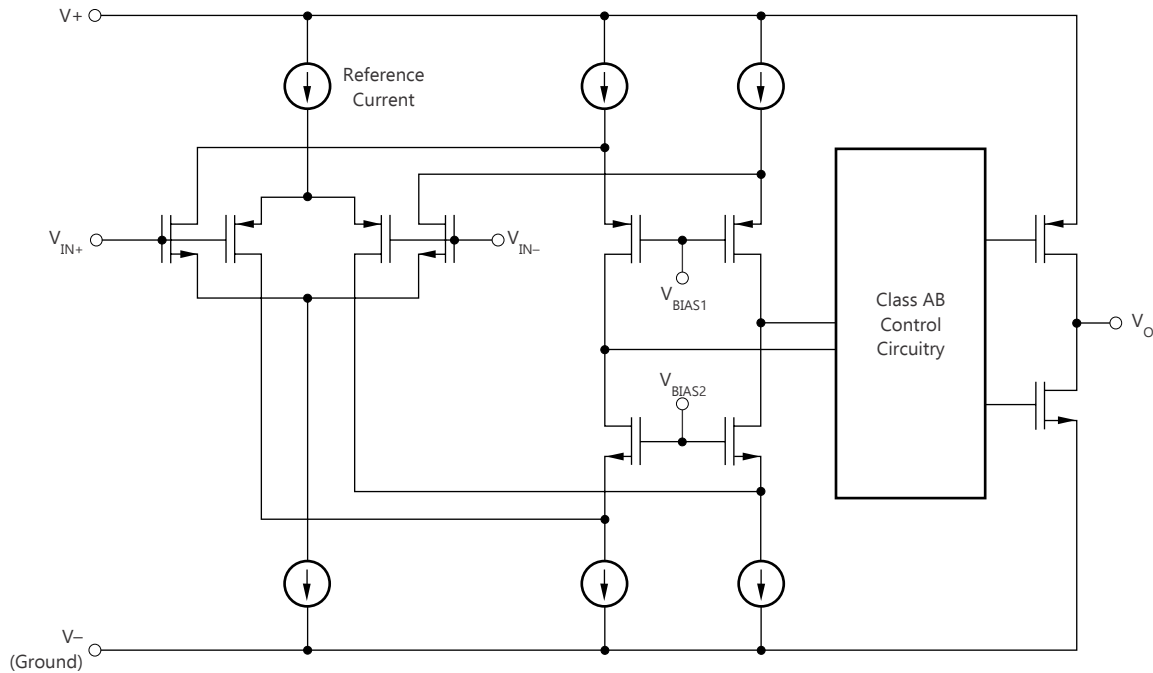
7.1 Overview

The TLV915x family (TLV9151, TLV9152, and TLV9154) is a family of 16-V general purpose operational amplifiers.

These devices offer excellent DC precision and AC performance, including rail-to-rail input/output, low offset ($\pm 125 \mu\text{V}$, typ), low offset drift ($\pm 0.3 \mu\text{V}/^\circ\text{C}$, typ), and 4.5-MHz bandwidth.

Wide differential and common-mode input-voltage range, high output current ($\pm 80 \text{ mA}$), high slew rate (21 $\text{V}/\mu\text{s}$), low power operation (560 μA , typ) and shutdown functionality make the TLV915x a robust, high-speed, high-performance operational amplifier for industrial applications.

7.2 Functional Block Diagram



7.3 Feature Description

7.3.1 EMI Rejection

The TLV915x uses integrated electromagnetic interference (EMI) filtering to reduce the effects of EMI from sources such as wireless communications and densely-populated boards with a mix of analog signal chain and digital components. EMI immunity can be improved with circuit design techniques; the TLV915x benefits from these design improvements. Texas Instruments has developed the ability to accurately measure and quantify the immunity of an operational amplifier over a broad frequency spectrum extending from 10 MHz to 6 GHz. [Figure 7-1](#) shows the results of this testing on the TLV915x. [Table 7-1](#) shows the EMIRR IN+ values for the TLV915x at particular frequencies commonly encountered in real-world applications. The [EMI Rejection Ratio of Operational Amplifiers](#) application report contains detailed information on the topic of EMIRR performance as it relates to op amps and is available for download from www.ti.com.

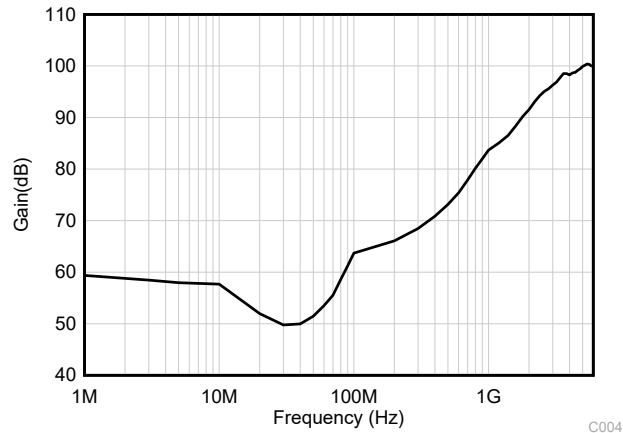


Figure 7-1. EMIRR Testing

Table 7-1. TLV9151 EMIRR IN+ for Frequencies of Interest

FREQUENCY	APPLICATION OR ALLOCATION	EMIRR IN+
400 MHz	Mobile radio, mobile satellite, space operation, weather, radar, ultra-high frequency (UHF) applications	73.2 dB
900 MHz	Global system for mobile communications (GSM) applications, radio communication, navigation, GPS (to 1.6 GHz), GSM, aeronautical mobile, UHF applications	82.5 dB
1.8 GHz	GSM applications, mobile personal communications, broadband, satellite, L-band (1 GHz to 2 GHz)	89.7 dB
2.4 GHz	802.11b, 802.11g, 802.11n, Bluetooth®, mobile personal communications, industrial, scientific and medical (ISM) radio band, amateur radio and satellite, S-band (2 GHz to 4 GHz)	93.9 dB
3.6 GHz	Radiolocation, aero communication and navigation, satellite, mobile, S-band	95.7 dB
5 GHz	802.11a, 802.11n, aero communication and navigation, mobile communication, space and satellite operation, C-band (4 GHz to 8 GHz)	98.0 dB

7.3.2 Thermal Protection

The internal power dissipation of any amplifier causes its internal (junction) temperature to rise. This phenomenon is called *self heating*. The absolute maximum junction temperature of the TLV915x is 150°C. Exceeding this temperature causes damage to the device. The TLV915x has a thermal protection feature that reduces damage from self heating. The protection works by monitoring the temperature of the device and turning off the op amp output drive for temperatures above 170°C. Figure 7-2 shows an application example for the TLV9151 that has significant self heating because of its power dissipation (0.81 W). Thermal calculations indicate that for an ambient temperature of 65°C, the device junction temperature must reach 177°C. The actual device, however, turns off the output drive to recover towards a safe junction temperature. Figure 7-2 shows how the circuit behaves during thermal protection. During normal operation, the device acts as a buffer so the output is 3 V. When self heating causes the device junction temperature to increase above the internal limit, the thermal protection forces the output to a high-impedance state and the output is pulled to ground through resistor R_L . If the condition that caused excessive power dissipation is not removed, the amplifier will oscillate between a shutdown and enabled state until the output fault is corrected.

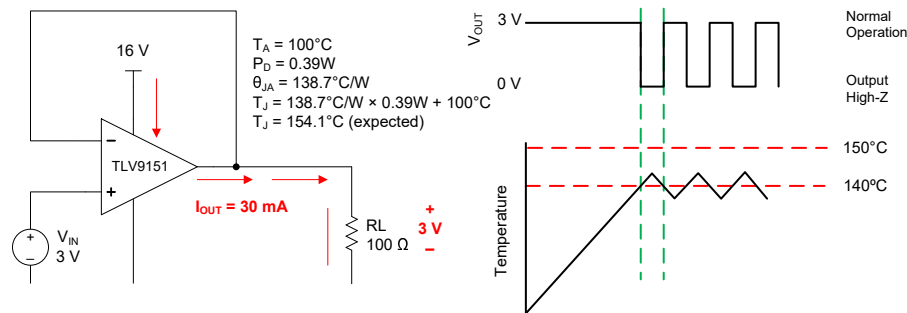


Figure 7-2. Thermal Protection

7.3.3 Capacitive Load and Stability

The TLV915x features a resistive output stage capable of driving moderate capacitive loads, and by leveraging an isolation resistor, the device can easily be configured to drive large capacitive loads. Increasing the gain enhances the ability of the amplifier to drive greater capacitive loads; see Figure 7-3 and Figure 7-4. The particular op amp circuit configuration, layout, gain, and output loading are some of the factors to consider when establishing whether an amplifier will be stable in operation.

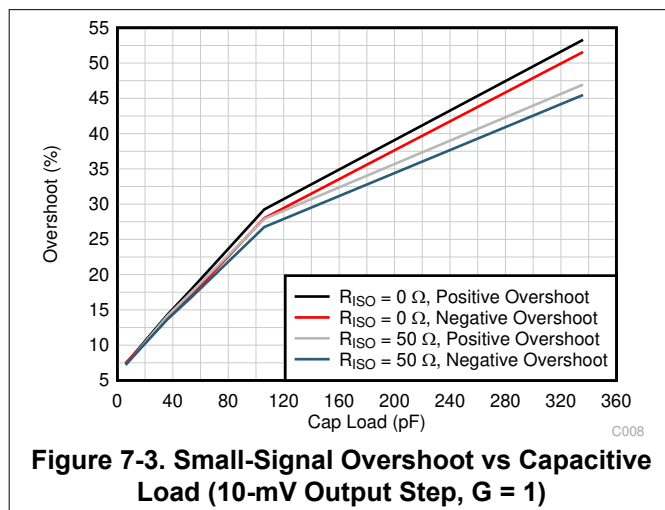


Figure 7-3. Small-Signal Overshoot vs Capacitive Load (10-mV Output Step, G = 1)

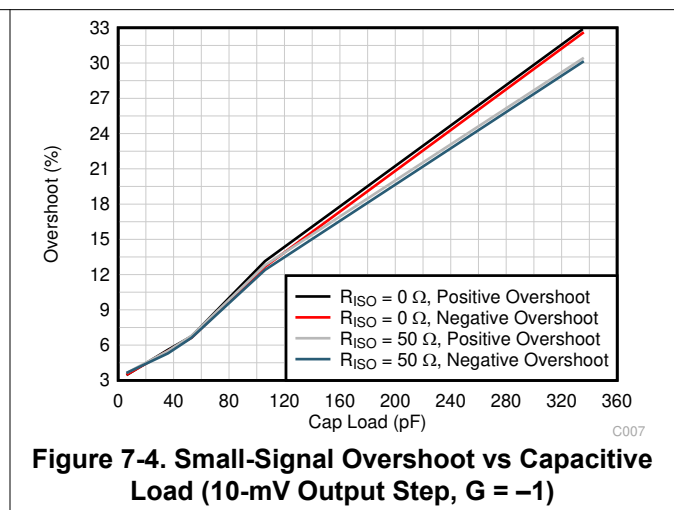


Figure 7-4. Small-Signal Overshoot vs Capacitive Load (10-mV Output Step, G = -1)

For additional drive capability in unity-gain configurations, improve capacitive load drive by inserting a small resistor, R_{ISO} , in series with the output, as shown in Figure 7-5. This resistor significantly reduces ringing and maintains DC performance for purely capacitive loads. However, if a resistive load is in parallel with the

capacitive load, then a voltage divider is created, thus introducing a gain error at the output and slightly reducing the output swing. The error introduced is proportional to the ratio R_{ISO} / R_L , and is generally negligible at low output levels. A high capacitive load drive makes the TLV915x well suited for applications such as reference buffers, MOSFET gate drives, and cable-shield drives. The circuit shown in Figure 7-5 uses an isolation resistor, R_{ISO} , to stabilize the output of an op amp. R_{ISO} modifies the open-loop gain of the system for increased phase margin.

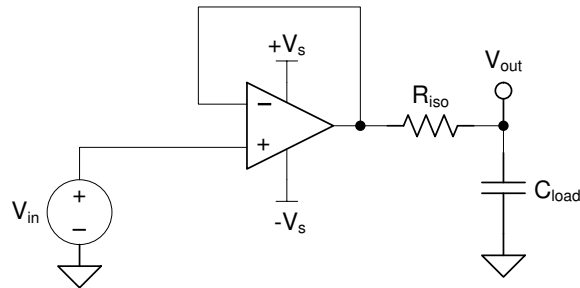


Figure 7-5. Extending Capacitive Load Drive With the TLV9151

7.3.4 Common-Mode Voltage Range

The TLV915x is a 16-V, rail-to-rail input operational amplifier with an input common-mode range that extends 200 mV beyond either supply rail. This wide range is achieved with paralleled complementary N-channel and P-channel differential input pairs, as shown in [Figure 7-6](#). The N-channel pair is active for input voltages close to the positive rail, typically $(V+) - 1\text{ V}$ to 100 mV above the positive supply. The P-channel pair is active for inputs from 100 mV below the negative supply to approximately $(V+) - 2\text{ V}$. There is a small transition region, typically $(V+) - 2\text{ V}$ to $(V+) - 1\text{ V}$ in which both input pairs are on. This transition region can vary modestly with process variation, and within this region PSRR, CMRR, offset voltage, offset drift, noise, and THD performance may be degraded compared to operation outside this region.

[Figure 6-5](#) shows this transition region for a typical device in terms of input voltage offset in more detail.

For more information on common-mode voltage range and PMOS/NMOS pair interaction, see [Op Amps With Complementary-Pair Input Stages](#) application note.

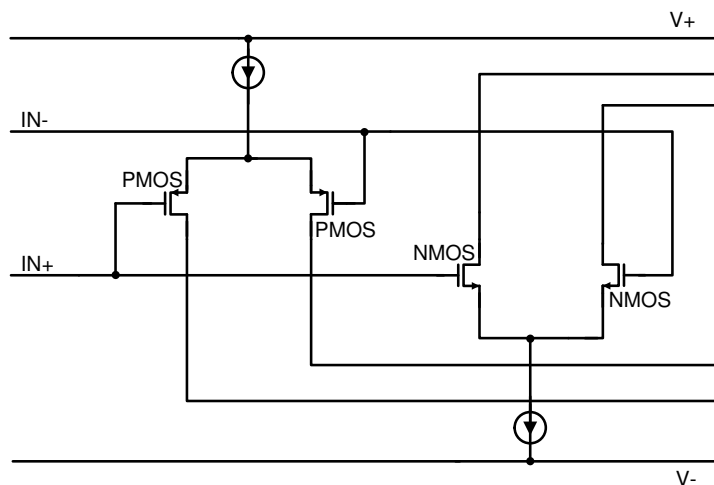


Figure 7-6. Rail-to-Rail Input Stage

7.3.5 Phase Reversal Protection

The TLV915x family has internal phase-reversal protection. Many op amps exhibit a phase reversal when the input is driven beyond its linear common-mode range. This condition is most often encountered in non-inverting circuits when the input is driven beyond the specified common-mode voltage range, causing the output to reverse into the opposite rail. The TLV915x is a rail-to-rail input op amp; therefore, the common-mode range can extend up to the rails. Input signals beyond the rails do not cause phase reversal; instead, the output limits into the appropriate rail. This performance is shown in [Figure 7-7](#). For more information on phase reversal, see [Op Amps With Complementary-Pair Input Stages](#) application note.

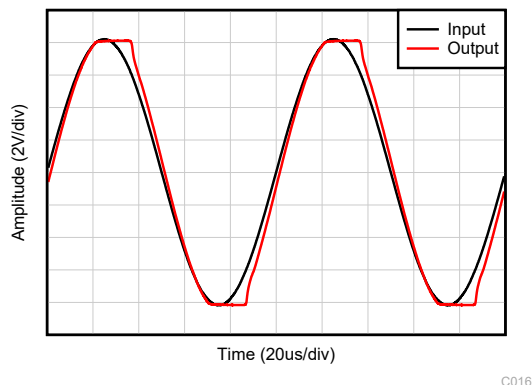


Figure 7-7. No Phase Reversal

7.3.6 Electrical Overstress

Designers often ask questions about the capability of an operational amplifier to withstand electrical overstress (EOS). These questions tend to focus on the device inputs, but may involve the supply voltage pins or even the output pin. Each of these different pin functions have electrical stress limits determined by the voltage breakdown characteristics of the particular semiconductor fabrication process and specific circuits connected to the pin. Additionally, internal electrostatic discharge (ESD) protection is built into these circuits to protect them from accidental ESD events both before and during product assembly.

Having a good understanding of this basic ESD circuitry and its relevance to an electrical overstress event is helpful. Figure 7-8 shows an illustration of the ESD circuits contained in the TLV915x (indicated by the dashed line area). The ESD protection circuitry involves several current-steering diodes connected from the input and output pins and routed back to the internal power-supply lines, where the diodes meet at an absorption device or the power-supply ESD cell, internal to the operational amplifier. This protection circuitry is intended to remain inactive during normal circuit operation.



Figure 7-8. Equivalent Internal ESD Circuitry Relative to a Typical Circuit Application

An ESD event is very short in duration and very high voltage (for example; 1 kV, 100 ns), whereas an EOS event is long duration and lower voltage (for example; 50 V, 100 ms). The ESD diodes are designed for out-of-circuit ESD protection (that is, during assembly, test, and storage of the device before being soldered to the PCB). During an ESD event, the ESD signal is passed through the ESD steering diodes to an absorption circuit (labeled ESD power-supply circuit). The ESD absorption circuit clamps the supplies to a safe level.

Although this behavior is necessary for out-of-circuit protection, excessive current and damage is caused if activated in-circuit. A transient voltage suppressors (TVS) can be used to prevent against damage caused by turning on the ESD absorption circuit during an in-circuit ESD event. Using the appropriate current limiting resistors and TVS diodes allows for the use of device ESD diodes to protect against EOS events.

7.3.7 Overload Recovery

Overload recovery is defined as the time required for the op amp output to recover from a saturated state to a linear state. The output devices of the op amp enter a saturation region when the output voltage exceeds the rated operating voltage, either due to the high input voltage or the high gain. After the device enters the saturation region, the charge carriers in the output devices require time to return back to the linear state. After the charge carriers return back to the linear state, the device begins to slew at the specified slew rate. Thus, the propagation delay in case of an overload condition is the sum of the overload recovery time and the slew time. The overload recovery time for the TLV915x is approximately 500 ns.

7.3.8 Typical Specifications and Distributions

Designers often have questions about a typical specification of an amplifier in order to design a more robust circuit. Due to natural variation in process technology and manufacturing procedures, every specification of an amplifier will exhibit some amount of deviation from the ideal value, like an amplifier's input offset voltage. These deviations often follow *Gaussian* ("bell curve"), or *normal* distributions, and circuit designers can leverage this information to guardband their system, even when there is not a minimum or maximum specification in the [Electrical Characteristics](#) table.

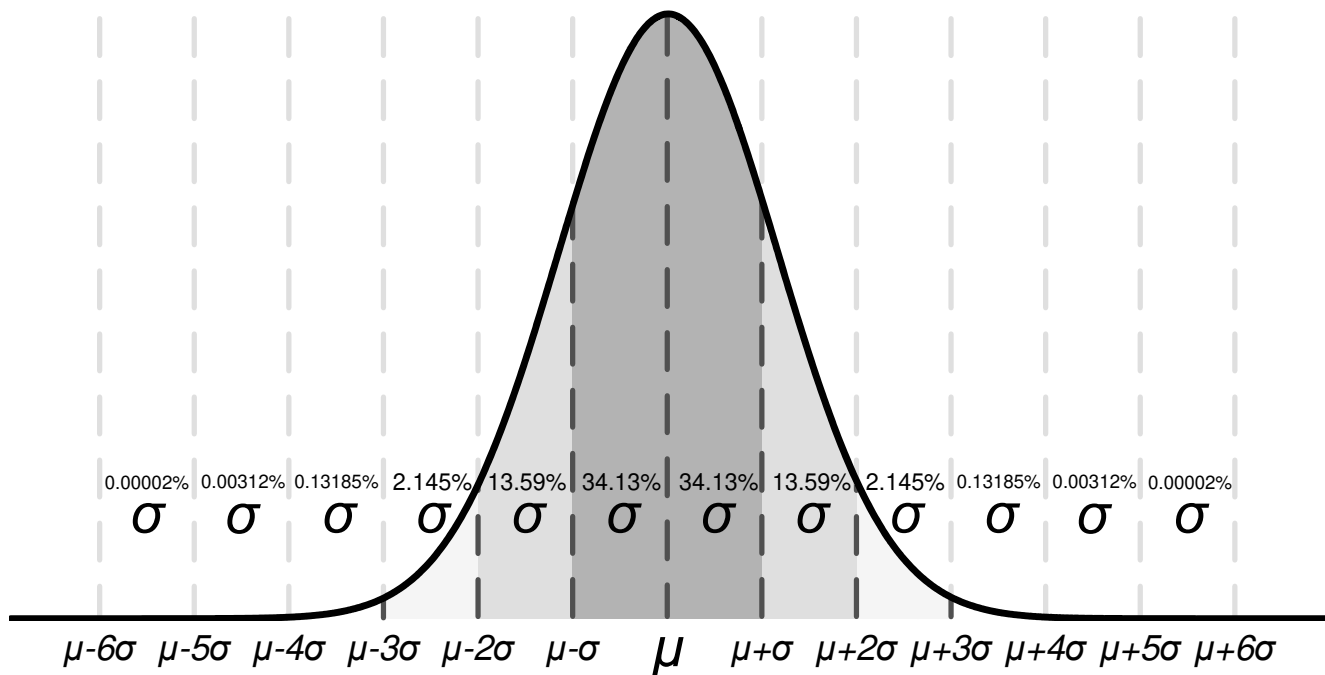


Figure 7-9. Ideal Gaussian Distribution

Figure 7-9 shows an example distribution, where μ , or mu , is the mean of the distribution, and where σ , or *sigma*, is the standard deviation of a system. For a specification that exhibits this kind of distribution, approximately two-thirds (68.26%) of all units can be expected to have a value within one standard deviation, or one sigma, of the mean (from $\mu - \sigma$ to $\mu + \sigma$).

Depending on the specification, values listed in the *typical* column of the [Electrical Characteristics](#) table are represented in different ways. As a general rule of thumb, if a specification naturally has a nonzero mean (for example, like gain bandwidth), then the typical value is equal to the mean (μ). However, if a specification naturally has a mean near zero (like input offset voltage), then the typical value is equal to the mean plus one standard deviation ($\mu + \sigma$) in order to most accurately represent the typical value.

You can use this chart to calculate approximate probability of a specification in a unit; for example, for TLV915x, the typical input voltage offset is 125 μV , so 68.2% of all TLV915x devices are expected to have an offset from

–125 μV to 125 μV . At 4 σ (± 500 μV), 99.9937% of the distribution has an offset voltage less than ± 500 μV , which means 0.0063% of the population is outside of these limits, which corresponds to about 1 in 15,873 units.

Specifications with a value in the minimum or maximum column are assured by TI, and units outside these limits will be removed from production material. For example, the TLV915x family has a maximum offset voltage of 675 μV at 25°C, and even though this corresponds to about 5 σ (≈ 1 in 1.7 million units), which is extremely unlikely, TI assures that any unit with larger offset than 675 μV will be removed from production material.

For specifications with no value in the minimum or maximum column, consider selecting a sigma value of sufficient guardband for your application, and design worst-case conditions using this value. For example, the 6- σ value corresponds to about 1 in 500 million units, which is an extremely unlikely chance, and could be an option as a wide guardband to design a system around. In this case, the TLV915x family does not have a maximum or minimum for offset voltage drift, but based on [Figure 6-2](#) and the typical value of 0.3 $\mu\text{V}/^\circ\text{C}$ in the [Electrical Characteristics](#) table, it can be calculated that the 6 σ value for offset voltage drift is about 1.8 $\mu\text{V}/^\circ\text{C}$. When designing for worst-case system conditions, this value can be used to estimate the worst possible offset across temperature without having an actual minimum or maximum value.

However, process variation and adjustments over time can shift typical means and standard deviations, and unless there is a value in the minimum or maximum specification column, TI cannot assure the performance of a device. This information should be used only to estimate the performance of a device.

7.3.9 Packages With an Exposed Thermal Pad

The TLV915x family is available in the WSON-8 (DSG) package which features an exposed thermal pad. Inside the package, the die is attached to this thermal pad using an electrically conductive compound. For this reason, when using a package with an exposed thermal pad, the thermal pad must either be connected to V^- or left floating. Attaching the thermal pad to a potential other than V^- is not allowed, and performance of the device is not assured when doing so.

7.3.10 Shutdown

The TLV915xS devices feature one or more shutdown pins (SHDN) that disable the op amp, placing it into a low-power standby mode. In this mode, the op amp typically consumes about 30 μA . The SHDN pins are active high, meaning that shutdown mode is enabled when the input to the SHDN pin is a valid logic high. The amplifier is enabled when the input to the SHDN pin is a valid logic low.

The SHDN pins are referenced to the negative supply rail of the op amp. The threshold of the shutdown feature lies around 800 mV (typical) and does not change with respect to the supply voltage. Hysteresis has been included in the switching threshold to ensure smooth switching characteristics. To ensure optimal shutdown behavior, the SHDN pins should be driven with valid logic signals. A valid logic low is defined as a voltage between V^- and $V^- + 0.2$ V. A valid logic high is defined as a voltage between $V^- + 1.1$ V and V^+ . The shutdown pin circuitry includes a pull-down resistor, which will inherently pull the voltage of the pin to the negative supply rail if not driven. Thus, to enable the amplifier, the SHDN pins should either be left floating or driven to a valid logic low. To disable the amplifier, the SHDN pins must be driven to a valid logic high. The maximum voltage allowed at the SHDN pins is V^+ .

The SHDN pins are high-impedance CMOS inputs. Channels of single and dual op amp packages are independently controlled, and channels of quad op amp packages are controlled in pairs. For battery-operated applications, this feature may be used to greatly reduce the average current and extend battery life. The typical enable time out of shutdown is 8 μs ; disable time is 3 μs . When disabled, the output assumes a high-impedance state. This architecture allows the TLV915xS family to operate as a gated amplifier, multiplexer, or programmable-gain amplifier. Shutdown time (t_{OFF}) depends on loading conditions and increases as load resistance increases. To ensure shutdown (disable) within a specific shutdown time, the specified 10-k Ω load to midsupply ($V_S / 2$) is required. If using the TLV915xS without a load, the resulting turnoff time significantly increases.

7.4 Device Functional Modes

The TLV915x has a single functional mode and is operational when the power-supply voltage is greater than 2.7 V (± 1.35 V). The maximum power supply voltage for the TLV915x is 16 V (± 8 V).

The TLV915xS devices feature a shutdown pin, which can be used to place the op amp into a low-power mode. See [Shutdown](#) section for more information.

8 Application and Implementation

Note

Information in the following applications sections is not part of the TI component specification, and TI does not warrant its accuracy or completeness. TI's customers are responsible for determining suitability of components for their purposes, as well as validating and testing their design implementation to confirm system functionality.

8.1 Application Information

The TLV915x family offers excellent DC precision and DC performance. These devices operate up to 16-V supply rails and offer true rail-to-rail input/output, low offset voltage and offset voltage drift, as well as 4.5-MHz bandwidth and high output drive. These features make the TLV915x a robust, high-performance operational amplifier for high-voltage industrial applications.

8.2 Typical Applications

8.2.1 Low-Side Current Measurement

Figure 8-1 shows the TLV9151 configured in a low-side current sensing application. For a full analysis of the circuit shown in Figure 8-1 including theory, calculations, simulations, and measured data, see TI Precision Design TIPD129, *0-A to 1-A Single-Supply Low-Side Current-Sensing Solution*.



Figure 8-1. TLV9151 in a Low-Side, Current-Sensing Application

8.2.1.1 Design Requirements

The design requirements for this design are:

- Load current: 0 A to 1 A
- Output voltage: 4.9 V
- Maximum shunt voltage: 100 mV

8.2.1.2 Detailed Design Procedure

The transfer function of the circuit in [Figure 8-1](#) is given in [Equation 1](#).

$$V_{\text{OUT}} = I_{\text{LOAD}} \times R_{\text{SHUNT}} \times \text{Gain} \quad (1)$$

The load current (I_{LOAD}) produces a voltage drop across the shunt resistor (R_{SHUNT}). The load current is set from 0 A to 1 A. To keep the shunt voltage below 100 mV at maximum load current, the largest shunt resistor is defined using [Equation 2](#).

$$R_{\text{SHUNT}} = \frac{V_{\text{SHUNT_MAX}}}{I_{\text{LOAD_MAX}}} = \frac{100\text{mV}}{1\text{A}} = 100\text{m}\Omega \quad (2)$$

Using [Equation 2](#), R_{SHUNT} is calculated to be 100 m Ω . The voltage drop produced by I_{LOAD} and R_{SHUNT} is amplified by the TLV9151 to produce an output voltage of 0 V to 4.9 V. The gain needed by the TLV9151 to produce the necessary output voltage is calculated using [Equation 3](#).

$$\text{Gain} = \frac{(V_{\text{OUT_MAX}} - V_{\text{OUT_MIN}})}{(V_{\text{IN_MAX}} - V_{\text{IN_MIN}})} \quad (3)$$

Using [Equation 3](#), the required gain is calculated to be 49 V/V, which is set with resistors R_{F} and R_{G} . [Equation 4](#) is used to size the resistors, R_{F} and R_{G} , to set the gain of the TLV9151 to 49 V/V.

$$\text{Gain} = 1 + \frac{(R_{\text{F}})}{(R_{\text{G}})} \quad (4)$$

Choosing R_{F} as 360 k Ω , R_{G} is calculated to be 7.5 k Ω . R_{F} and R_{G} were chosen as 360 k Ω and 7.5 k Ω because they are standard value resistors that create a 49:1 ratio. Other resistors that create a 49:1 ratio can also be used. [Figure 8-2](#) shows the measured transfer function of the circuit shown in [Figure 8-1](#).

8.2.1.3 Application Curves



Figure 8-2. Low-Side, Current-Sense, Transfer Function

9 Power Supply Recommendations

The TLV915x is specified for operation from 2.7 V to 16 V (± 1.35 V to ± 8 V); many specifications apply from -40°C to 125°C . Parameters that can exhibit significant variance with regard to operating voltage or temperature are presented in the [Typical Characteristics](#).

CAUTION

Supply voltages larger than 16 V can permanently damage the device; see the [Absolute Maximum Ratings](#).

Place 0.1- μF bypass capacitors close to the power-supply pins to reduce errors coupling in from noisy or high-impedance power supplies. For more detailed information on bypass capacitor placement, refer to the [Layout](#) section.

10 Layout

10.1 Layout Guidelines

For best operational performance of the device, use good PCB layout practices, including:

- Noise can propagate into analog circuitry through the power pins of the circuit as a whole and op amp itself. Bypass capacitors are used to reduce the coupled noise by providing low-impedance power sources local to the analog circuitry.
 - Connect low-ESR, 0.1- μF ceramic bypass capacitors between each supply pin and ground, placed as close to the device as possible. A single bypass capacitor from V+ to ground is applicable for single-supply applications.
- Separate grounding for analog and digital portions of circuitry is one of the simplest and most-effective methods of noise suppression. One or more layers on multilayer PCBs are usually devoted to ground planes. A ground plane helps distribute heat and reduces EMI noise pickup. Make sure to physically separate digital and analog grounds paying attention to the flow of the ground current.
- In order to reduce parasitic coupling, run the input traces as far away from the supply or output traces as possible. If these traces cannot be kept separate, crossing the sensitive trace perpendicular is much better as opposed to in parallel with the noisy trace.
- Place the external components as close to the device as possible. As illustrated in [Figure 10-2](#), keeping RF and RG close to the inverting input minimizes parasitic capacitance.
- Keep the length of input traces as short as possible. Always remember that the input traces are the most sensitive part of the circuit.
- Consider a driven, low-impedance guard ring around the critical traces. A guard ring can significantly reduce leakage currents from nearby traces that are at different potentials.
- Cleaning the PCB following board assembly is recommended for best performance.
- Any precision integrated circuit may experience performance shifts due to moisture ingress into the plastic package. Following any aqueous PCB cleaning process, baking the PCB assembly is recommended to remove moisture introduced into the device packaging during the cleaning process. A low temperature, post cleaning bake at 85°C for 30 minutes is sufficient for most circumstances.

10.2 Layout Example



Figure 10-1. Schematic Representation



Figure 10-2. Operational Amplifier Board Layout for Noninverting Configuration

11 Device and Documentation Support

11.1 Device Support

11.1.1 Development Support

11.1.1.1 TINA-TI™ (Free Software Download)

TINA™ is a simple, powerful, and easy-to-use circuit simulation program based on a SPICE engine. TINA-TI is a free, fully-functional version of the TINA software, preloaded with a library of macro models in addition to a range of both passive and active models. TINA-TI provides all the conventional dc, transient, and frequency domain analysis of SPICE, as well as additional design capabilities.

Available as a [free download](#) from the Analog eLab Design Center, TINA-TI offers extensive post-processing capability that allows users to format results in a variety of ways. Virtual instruments offer the ability to select input waveforms and probe circuit nodes, voltages, and waveforms, creating a dynamic quick-start tool.

Note

These files require that either the TINA software (from DesignSoft™) or TINA-TI software be installed. Download the free TINA-TI software from the [TINA-TI folder](#).

11.1.1.2 TI Precision Designs

The TLV915x is featured in several TI Precision Designs, available online at <http://www.ti.com/ww/en/analog/precision-designs/>. TI Precision Designs are analog solutions created by TI's precision analog applications experts and offer the theory of operation, component selection, simulation, complete PCB schematic and layout, bill of materials, and measured performance of many useful circuits.

11.2 Documentation Support

11.2.1 Related Documentation

Texas Instruments, [Analog Engineer's Circuit Cookbook: Amplifiers](#).

Texas Instruments, [AN31 amplifier circuit collection](#).

11.3 Receiving Notification of Documentation Updates

To receive notification of documentation updates, navigate to the device product folder on [ti.com](#). Click on *Subscribe to updates* to register and receive a weekly digest of any product information that has changed. For change details, review the revision history included in any revised document.

11.4 Support Resources

[TI E2E™ support forums](#) are an engineer's go-to source for fast, verified answers and design help — straight from the experts. Search existing answers or ask your own question to get the quick design help you need.

Linked content is provided "AS IS" by the respective contributors. They do not constitute TI specifications and do not necessarily reflect TI's views; see TI's [Terms of Use](#).

11.5 Trademarks

TINA-TI™ is a trademark of Texas Instruments, Inc and DesignSoft, Inc.

TINA™ and DesignSoft™ are trademarks of DesignSoft, Inc.

TI E2E™ is a trademark of Texas Instruments.

Bluetooth® is a registered trademark of Bluetooth SIG, Inc.

All trademarks are the property of their respective owners.

11.6 Electrostatic Discharge Caution



This integrated circuit can be damaged by ESD. Texas Instruments recommends that all integrated circuits be handled with appropriate precautions. Failure to observe proper handling and installation procedures can cause damage.

ESD damage can range from subtle performance degradation to complete device failure. Precision integrated circuits may be more susceptible to damage because very small parametric changes could cause the device not to meet its published specifications.

11.7 Glossary

[TI Glossary](#) This glossary lists and explains terms, acronyms, and definitions.

12 Mechanical, Packaging, and Orderable Information

The following pages include mechanical, packaging, and orderable information. This information is the most current data available for the designated devices. This data is subject to change without notice and revision of this document. For browser-based versions of this data sheet, refer to the left-hand navigation.

PACKAGING INFORMATION

Orderable Device	Status (1)	Package Type	Package Drawing	Pins	Package Qty	Eco Plan (2)	Lead finish/ Ball material (6)	MSL Peak Temp (3)	Op Temp (°C)	Device Marking (4/5)	Samples
TLV9151IDBVR	ACTIVE	SOT-23	DBV	5	3000	RoHS & Green	NIPDAU SN	Level-1-260C-UNLIM	-40 to 125	T51V	Samples
TLV9151IDCKR	ACTIVE	SC70	DCK	5	3000	RoHS & Green	SN	Level-2-260C-1 YEAR	-40 to 125	1HD	Samples
TLV9151SIDBVR	ACTIVE	SOT-23	DBV	6	3000	RoHS & Green	NIPDAU	Level-1-260C-UNLIM	-40 to 125	T91S	Samples
TLV9152IDDFR	ACTIVE	SOT-23-THIN	DDF	8	3000	RoHS & Green	NIPDAU	Level-1-260C-UNLIM	-40 to 125	T52F	Samples
TLV9152IDGKR	ACTIVE	VSSOP	DGK	8	2500	RoHS & Green	SN	Level-1-260C-UNLIM	-40 to 125	27TT	Samples
TLV9152IDR	ACTIVE	SOIC	D	8	2500	RoHS & Green	NIPDAU	Level-1-260C-UNLIM	-40 to 125	T9152D	Samples
TLV9152IDSGR	ACTIVE	WSON	DSG	8	3000	RoHS & Green	NIPDAU	Level-1-260C-UNLIM	-40 to 125	T52G	Samples
TLV9152IPWR	ACTIVE	TSSOP	PW	8	2000	RoHS & Green	NIPDAU	Level-1-260C-UNLIM	-40 to 125	T9152P	Samples
TLV9152SIRUGR	ACTIVE	X2QFN	RUG	10	3000	RoHS & Green	NIPDAUAG	Level-2-260C-1 YEAR	-40 to 125	GSF	Samples
TLV9154IDR	ACTIVE	SOIC	D	14	2500	RoHS & Green	NIPDAU	Level-1-260C-UNLIM	-40 to 125	TLV9154D	Samples
TLV9154IDYYR	ACTIVE	SOT-23-THIN	DYY	14	3000	RoHS & Green	NIPDAU	Level-1-260C-UNLIM	-40 to 125	TLV9154I	Samples
TLV9154IPWR	ACTIVE	TSSOP	PW	14	2000	RoHS & Green	NIPDAU SN	Level-2-260C-1 YEAR	-40 to 125	(TL9154, TL9154PW)	Samples
TLV9154IRUCR	ACTIVE	QFN	RUC	14	3000	RoHS & Green	NIPDAU	Level-2-260C-1 YEAR	-40 to 125	I5F	Samples

(1) The marketing status values are defined as follows:

ACTIVE: Product device recommended for new designs.

LIFEBUY: TI has announced that the device will be discontinued, and a lifetime-buy period is in effect.

NRND: Not recommended for new designs. Device is in production to support existing customers, but TI does not recommend using this part in a new design.

PREVIEW: Device has been announced but is not in production. Samples may or may not be available.

OBSOLETE: TI has discontinued the production of the device.

(2) **RoHS:** TI defines "RoHS" to mean semiconductor products that are compliant with the current EU RoHS requirements for all 10 RoHS substances, including the requirement that RoHS substance do not exceed 0.1% by weight in homogeneous materials. Where designed to be soldered at high temperatures, "RoHS" products are suitable for use in specified lead-free processes. TI may reference these types of products as "Pb-Free".

RoHS Exempt: TI defines "RoHS Exempt" to mean products that contain lead but are compliant with EU RoHS pursuant to a specific EU RoHS exemption.

Green: TI defines "Green" to mean the content of Chlorine (Cl) and Bromine (Br) based flame retardants meet JS709B low halogen requirements of ≤ 1000 ppm threshold. Antimony trioxide based flame retardants must also meet the ≤ 1000 ppm threshold requirement.

- (3) MSL, Peak Temp. - The Moisture Sensitivity Level rating according to the JEDEC industry standard classifications, and peak solder temperature.
- (4) There may be additional marking, which relates to the logo, the lot trace code information, or the environmental category on the device.
- (5) Multiple Device Markings will be inside parentheses. Only one Device Marking contained in parentheses and separated by a "~" will appear on a device. If a line is indented then it is a continuation of the previous line and the two combined represent the entire Device Marking for that device.
- (6) Lead finish/Ball material - Orderable Devices may have multiple material finish options. Finish options are separated by a vertical ruled line. Lead finish/Ball material values may wrap to two lines if the finish value exceeds the maximum column width.

Important Information and Disclaimer: The information provided on this page represents TI's knowledge and belief as of the date that it is provided. TI bases its knowledge and belief on information provided by third parties, and makes no representation or warranty as to the accuracy of such information. Efforts are underway to better integrate information from third parties. TI has taken and continues to take reasonable steps to provide representative and accurate information but may not have conducted destructive testing or chemical analysis on incoming materials and chemicals. TI and TI suppliers consider certain information to be proprietary, and thus CAS numbers and other limited information may not be available for release.

In no event shall TI's liability arising out of such information exceed the total purchase price of the TI part(s) at issue in this document sold by TI to Customer on an annual basis.

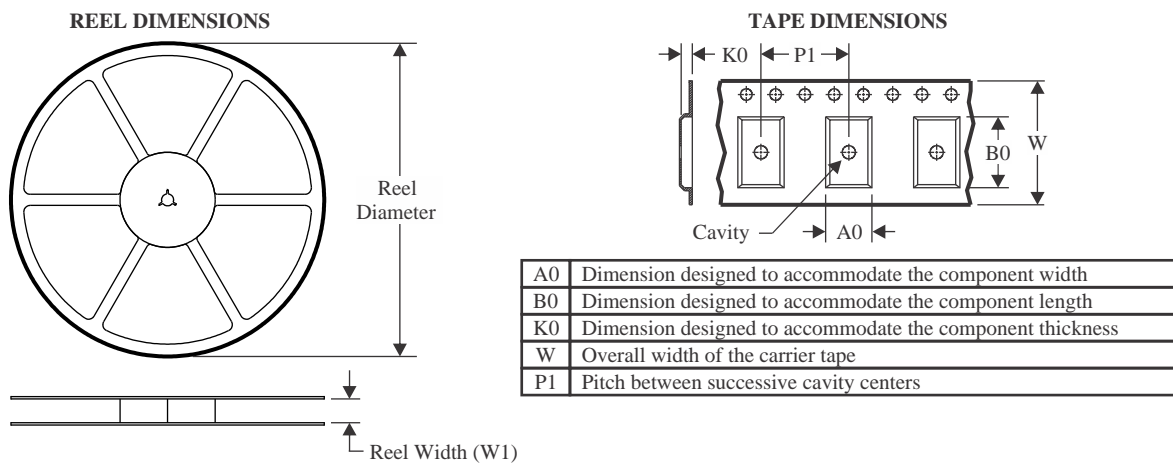
OTHER QUALIFIED VERSIONS OF TLV9151, TLV9152, TLV9154 :

- Automotive : [TLV9151-Q1](#), [TLV9152-Q1](#), [TLV9154-Q1](#)

NOTE: Qualified Version Definitions:

- Automotive - Q100 devices qualified for high-reliability automotive applications targeting zero defects

TAPE AND REEL INFORMATION



QUADRANT ASSIGNMENTS FOR PIN 1 ORIENTATION IN TAPE



*All dimensions are nominal

Device	Package Type	Package Drawing	Pins	SPQ	Reel Diameter (mm)	Reel Width W1 (mm)	A0 (mm)	B0 (mm)	K0 (mm)	P1 (mm)	W (mm)	Pin1 Quadrant
TLV9151IDBVR	SOT-23	DBV	5	3000	180.0	8.4	3.2	3.2	1.4	4.0	8.0	Q3
TLV9151IDCKR	SC70	DCK	5	3000	178.0	9.0	2.4	2.5	1.2	4.0	8.0	Q3
TLV9151SIDBVR	SOT-23	DBV	6	3000	180.0	8.4	3.2	3.2	1.4	4.0	8.0	Q3
TLV9152IDDFR	SOT-23-THIN	DDF	8	3000	180.0	8.4	3.2	3.2	1.4	4.0	8.0	Q3
TLV9152IDGKR	VSSOP	DGK	8	2500	330.0	12.4	5.3	3.4	1.4	8.0	12.0	Q1
TLV9152IDR	SOIC	D	8	2500	330.0	12.4	6.4	5.2	2.1	8.0	12.0	Q1
TLV9152IDSGR	WSON	DSG	8	3000	180.0	8.4	2.3	2.3	1.15	4.0	8.0	Q2
TLV9152IPWR	TSSOP	PW	8	2000	330.0	12.4	7.0	3.6	1.6	8.0	12.0	Q1
TLV9152SIRUGR	X2QFN	RUG	10	3000	178.0	8.4	1.75	2.25	0.56	4.0	8.0	Q1
TLV9154IDR	SOIC	D	14	2500	330.0	16.4	6.5	9.0	2.1	8.0	16.0	Q1
TLV9154IDYYR	SOT-23-THIN	DYY	14	3000	330.0	12.4	4.8	3.6	1.6	8.0	12.0	Q3
TLV9154IPWR	TSSOP	PW	14	2000	330.0	12.4	6.9	5.6	1.6	8.0	12.0	Q1
TLV9154IRUCR	QFN	RUC	14	3000	180.0	9.5	2.16	2.16	0.5	4.0	8.0	Q2

TAPE AND REEL BOX DIMENSIONS


*All dimensions are nominal

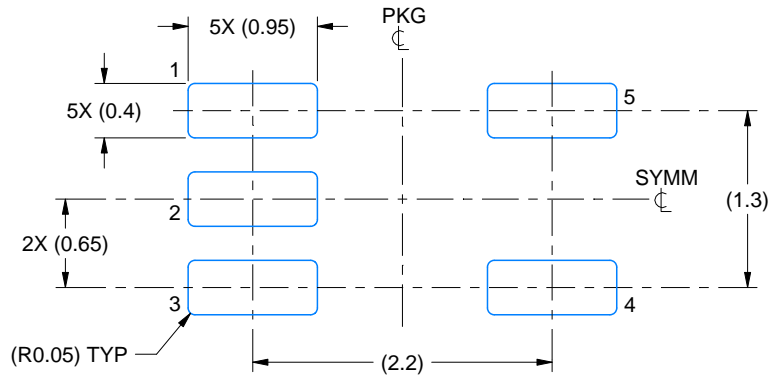
Device	Package Type	Package Drawing	Pins	SPQ	Length (mm)	Width (mm)	Height (mm)
TLV9151IDBVR	SOT-23	DBV	5	3000	210.0	185.0	35.0
TLV9151IDCKR	SC70	DCK	5	3000	190.0	190.0	30.0
TLV9151SIDBVR	SOT-23	DBV	6	3000	210.0	185.0	35.0
TLV9152IDDFR	SOT-23-THIN	DDF	8	3000	210.0	185.0	35.0
TLV9152IDGKR	VSSOP	DGK	8	2500	366.0	364.0	50.0
TLV9152IDR	SOIC	D	8	2500	356.0	356.0	35.0
TLV9152IDSGR	WSON	DSG	8	3000	210.0	185.0	35.0
TLV9152IPWR	TSSOP	PW	8	2000	356.0	356.0	35.0
TLV9152SIRUGR	X2QFN	RUG	10	3000	205.0	200.0	33.0
TLV9154IDR	SOIC	D	14	2500	356.0	356.0	35.0
TLV9154IDYYR	SOT-23-THIN	DYY	14	3000	336.6	336.6	31.8
TLV9154IPWR	TSSOP	PW	14	2000	366.0	364.0	50.0
TLV9154IRUCR	QFN	RUC	14	3000	205.0	200.0	30.0

EXAMPLE BOARD LAYOUT

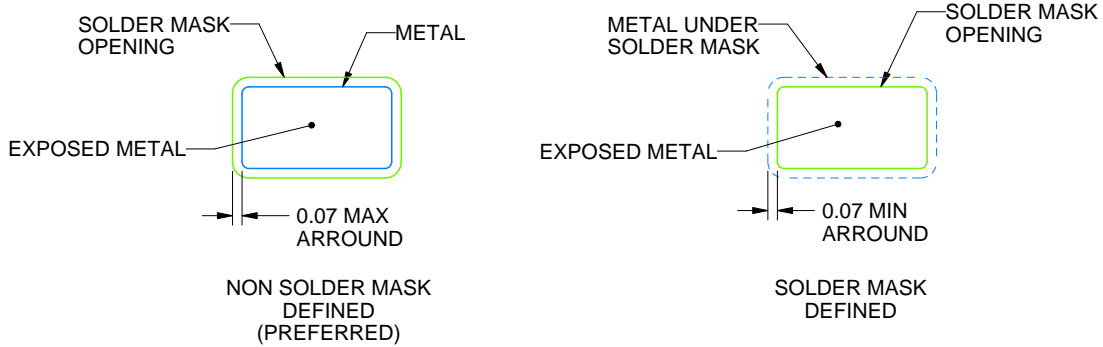
DCK0005A

SOT - 1.1 max height

SMALL OUTLINE TRANSISTOR



LAND PATTERN EXAMPLE
EXPOSED METAL SHOWN
SCALE:18X



SOLDER MASK DETAILS

4214834/C 03/2023

NOTES: (continued)

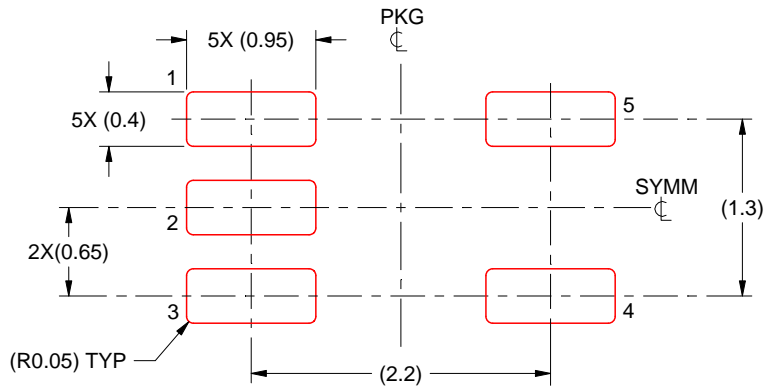
- 4. Publication IPC-7351 may have alternate designs.
- 5. Solder mask tolerances between and around signal pads can vary based on board fabrication site.

EXAMPLE STENCIL DESIGN

DCK0005A

SOT - 1.1 max height

SMALL OUTLINE TRANSISTOR



SOLDER PASTE EXAMPLE
BASED ON 0.125 THICK STENCIL
SCALE:18X

4214834/C 03/2023

NOTES: (continued)

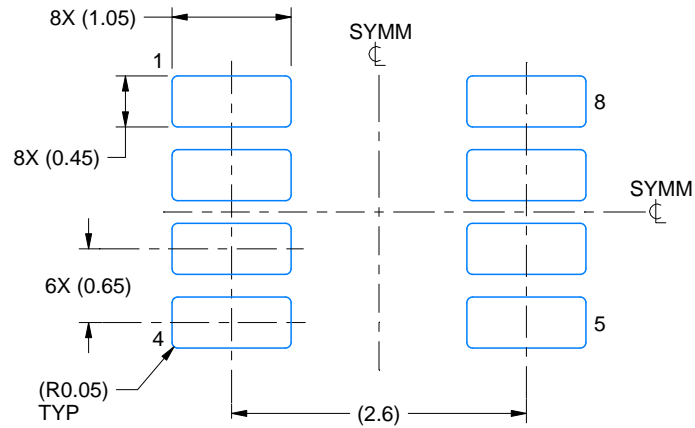
6. Laser cutting apertures with trapezoidal walls and rounded corners may offer better paste release. IPC-7525 may have alternate design recommendations.
7. Board assembly site may have different recommendations for stencil design.

EXAMPLE BOARD LAYOUT

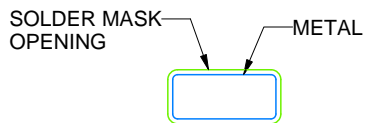
DDF0008A

SOT-23 - 1.1 mm max height

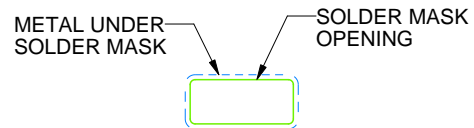
PLASTIC SMALL OUTLINE



LAND PATTERN EXAMPLE
SCALE:15X



NON SOLDER MASK
DEFINED



SOLDER MASK
DEFINED

SOLDER MASK DETAILS

4222047/C 10/2022

NOTES: (continued)

4. Publication IPC-7351 may have alternate designs.
5. Solder mask tolerances between and around signal pads can vary based on board fabrication site.

EXAMPLE STENCIL DESIGN

DDF0008A

SOT-23 - 1.1 mm max height

PLASTIC SMALL OUTLINE

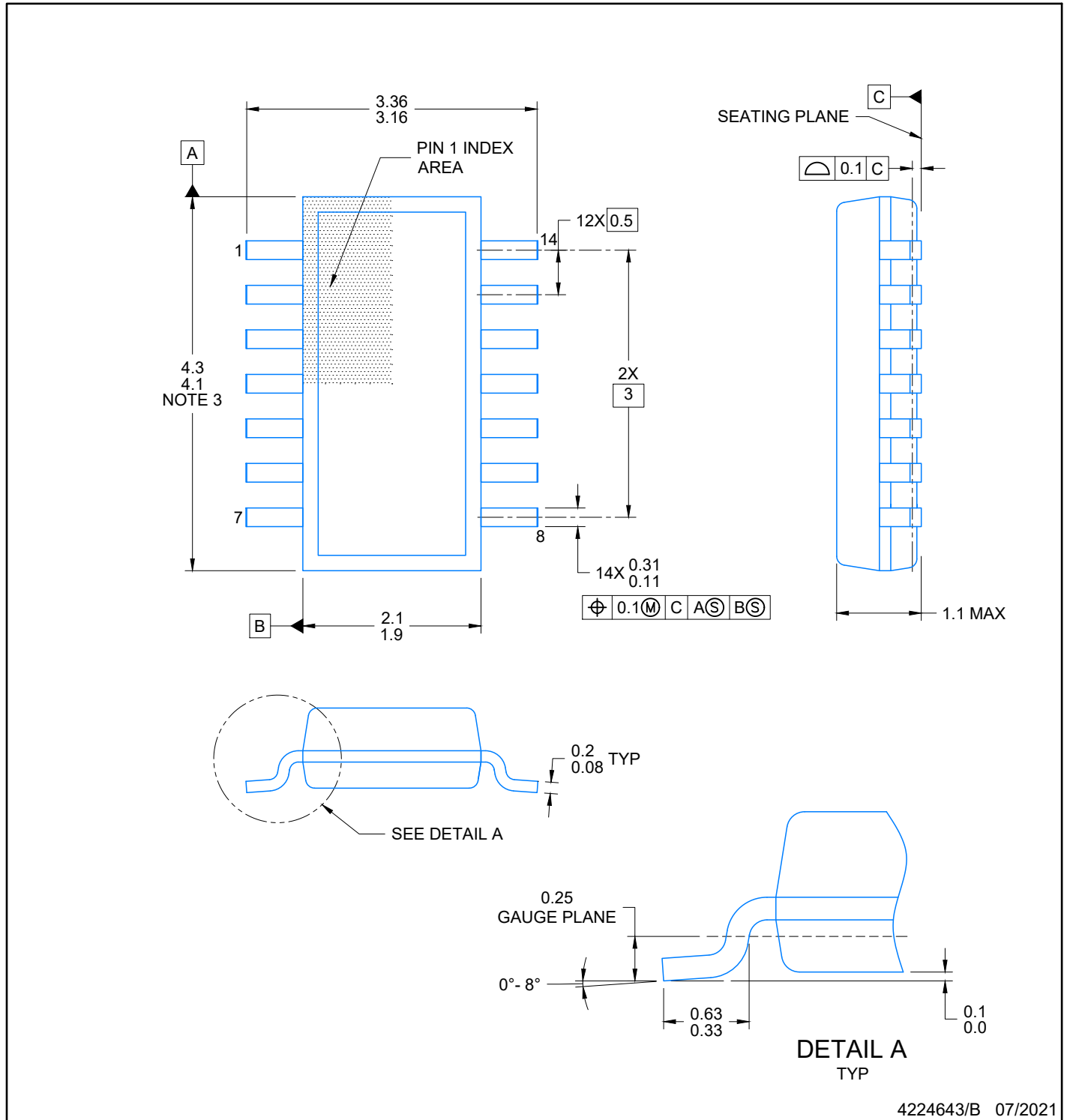


SOLDER PASTE EXAMPLE
BASED ON 0.125 mm THICK STENCIL
SCALE:15X

4222047/C 10/2022

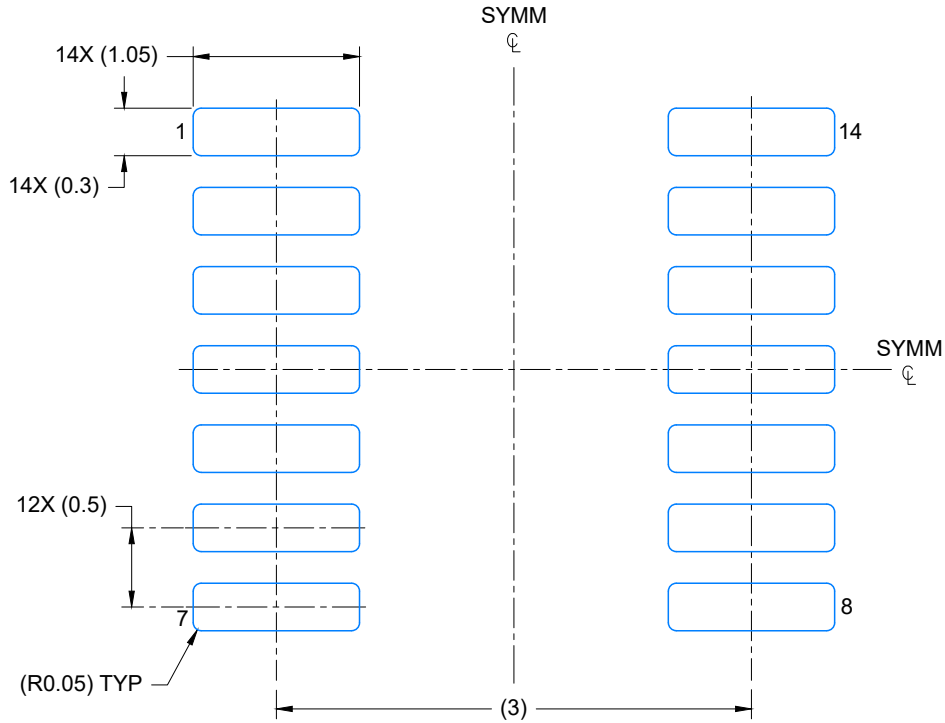
NOTES: (continued)

6. Laser cutting apertures with trapezoidal walls and rounded corners may offer better paste release. IPC-7525 may have alternate design recommendations.
7. Board assembly site may have different recommendations for stencil design.

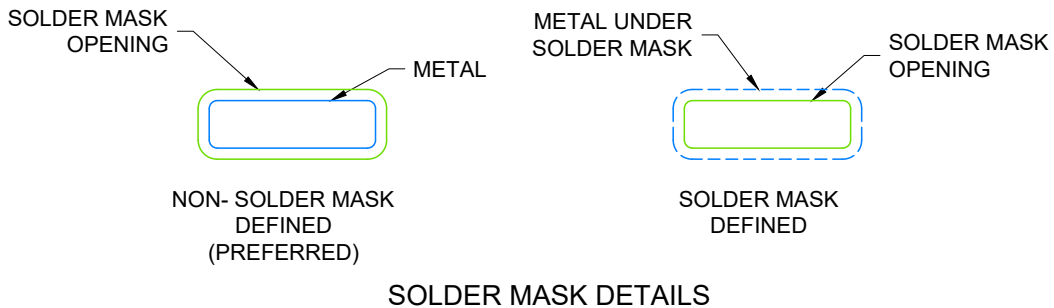


NOTES:

1. All linear dimensions are in millimeters. Any dimensions in parenthesis are for reference only. Dimensioning and tolerancing per ASME Y14.5M.
2. This drawing is subject to change without notice.
3. This dimension does not include mold flash, protrusions, or gate burrs. Mold flash, protrusions, or gate burrs shall not exceed 0.15 per side.
4. This dimension does not include interlead flash. Interlead flash shall not exceed 0.50 per side.
5. Reference JEDEC Registration MO-345, Variation AB



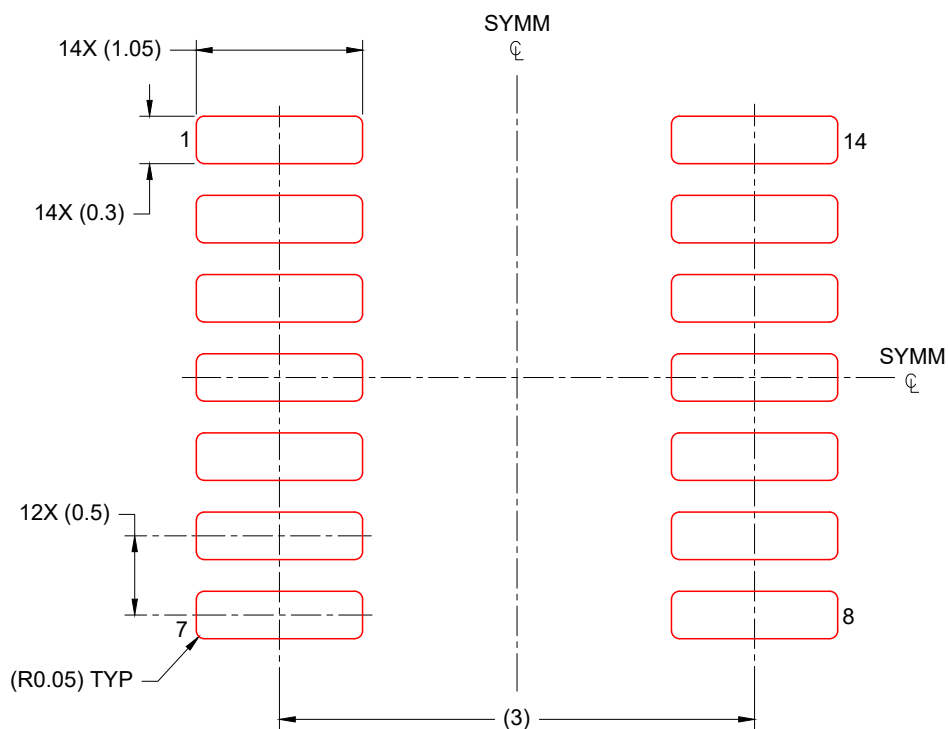
LAND PATTERN EXAMPLE
EXPOSED METAL SHOWN
SCALE: 20X



4224643/B 07/2021

NOTES: (continued)

- 6. Publication IPC-7351 may have alternate designs.
- 7. Solder mask tolerances between and around signal pads can vary based on board fabrication site.



SOLDER PASTE EXAMPLE
 BASED ON 0.125 mm THICK STENCIL
 SCALE: 20X

4224643/B 07/2021

NOTES: (continued)

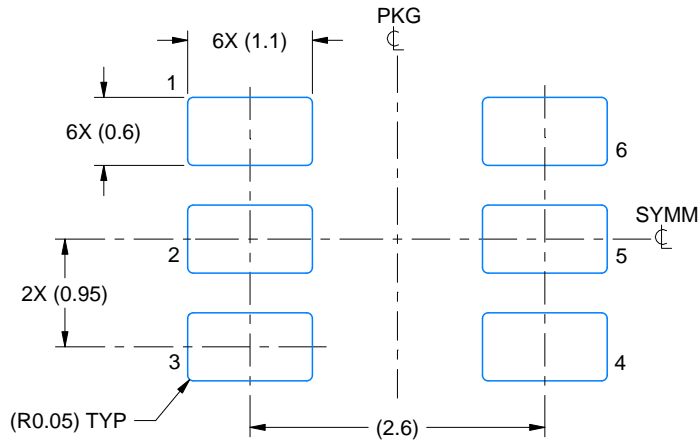
8. Laser cutting apertures with trapezoidal walls and rounded corners may offer better paste release. IPC-7525 may have alternate design recommendations.
9. Board assembly site may have different recommendations for stencil design.

EXAMPLE BOARD LAYOUT

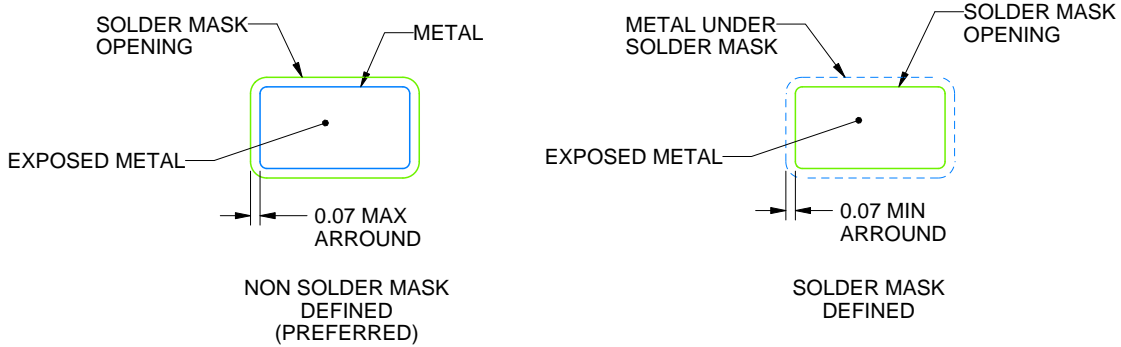
DBV0006A

SOT-23 - 1.45 mm max height

SMALL OUTLINE TRANSISTOR



LAND PATTERN EXAMPLE
EXPOSED METAL SHOWN
SCALE:15X



SOLDER MASK DETAILS

4214840/D 09/2023

NOTES: (continued)

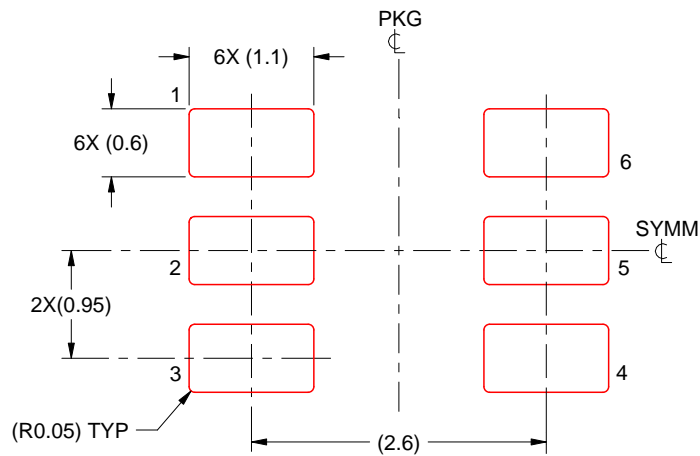
- 6. Publication IPC-7351 may have alternate designs.
- 7. Solder mask tolerances between and around signal pads can vary based on board fabrication site.

EXAMPLE STENCIL DESIGN

DBV0006A

SOT-23 - 1.45 mm max height

SMALL OUTLINE TRANSISTOR



SOLDER PASTE EXAMPLE
BASED ON 0.125 mm THICK STENCIL
SCALE:15X

4214840/D 09/2023

NOTES: (continued)

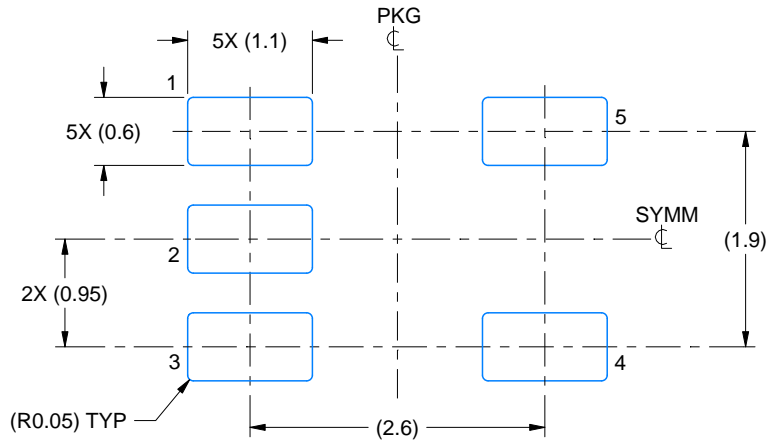
8. Laser cutting apertures with trapezoidal walls and rounded corners may offer better paste release. IPC-7525 may have alternate design recommendations.
9. Board assembly site may have different recommendations for stencil design.

EXAMPLE BOARD LAYOUT

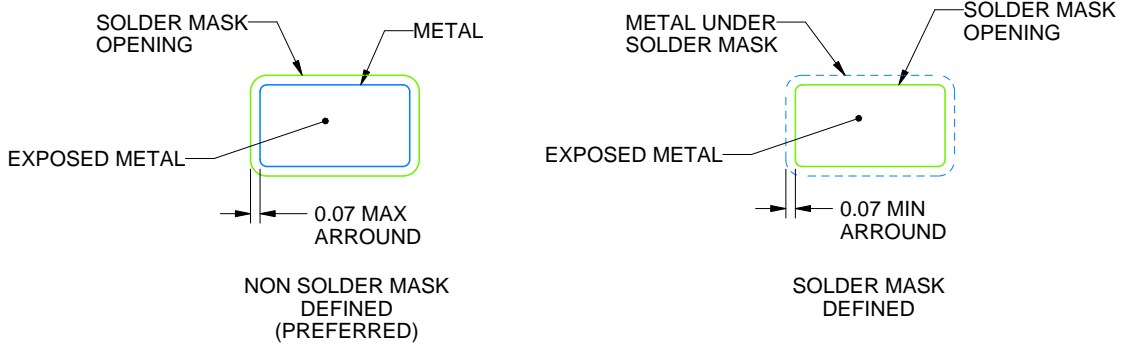
DBV0005A

SOT-23 - 1.45 mm max height

SMALL OUTLINE TRANSISTOR



LAND PATTERN EXAMPLE
EXPOSED METAL SHOWN
SCALE:15X



SOLDER MASK DETAILS

4214839/H 09/2023

NOTES: (continued)

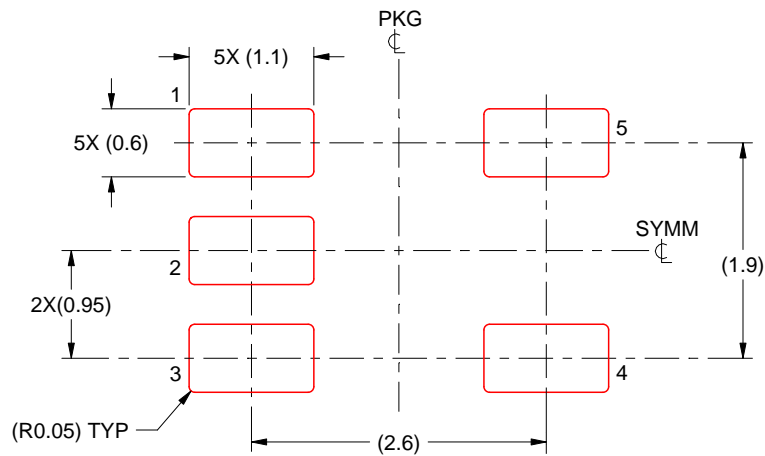
- 6. Publication IPC-7351 may have alternate designs.
- 7. Solder mask tolerances between and around signal pads can vary based on board fabrication site.

EXAMPLE STENCIL DESIGN

DBV0005A

SOT-23 - 1.45 mm max height

SMALL OUTLINE TRANSISTOR



SOLDER PASTE EXAMPLE
BASED ON 0.125 mm THICK STENCIL
SCALE:15X

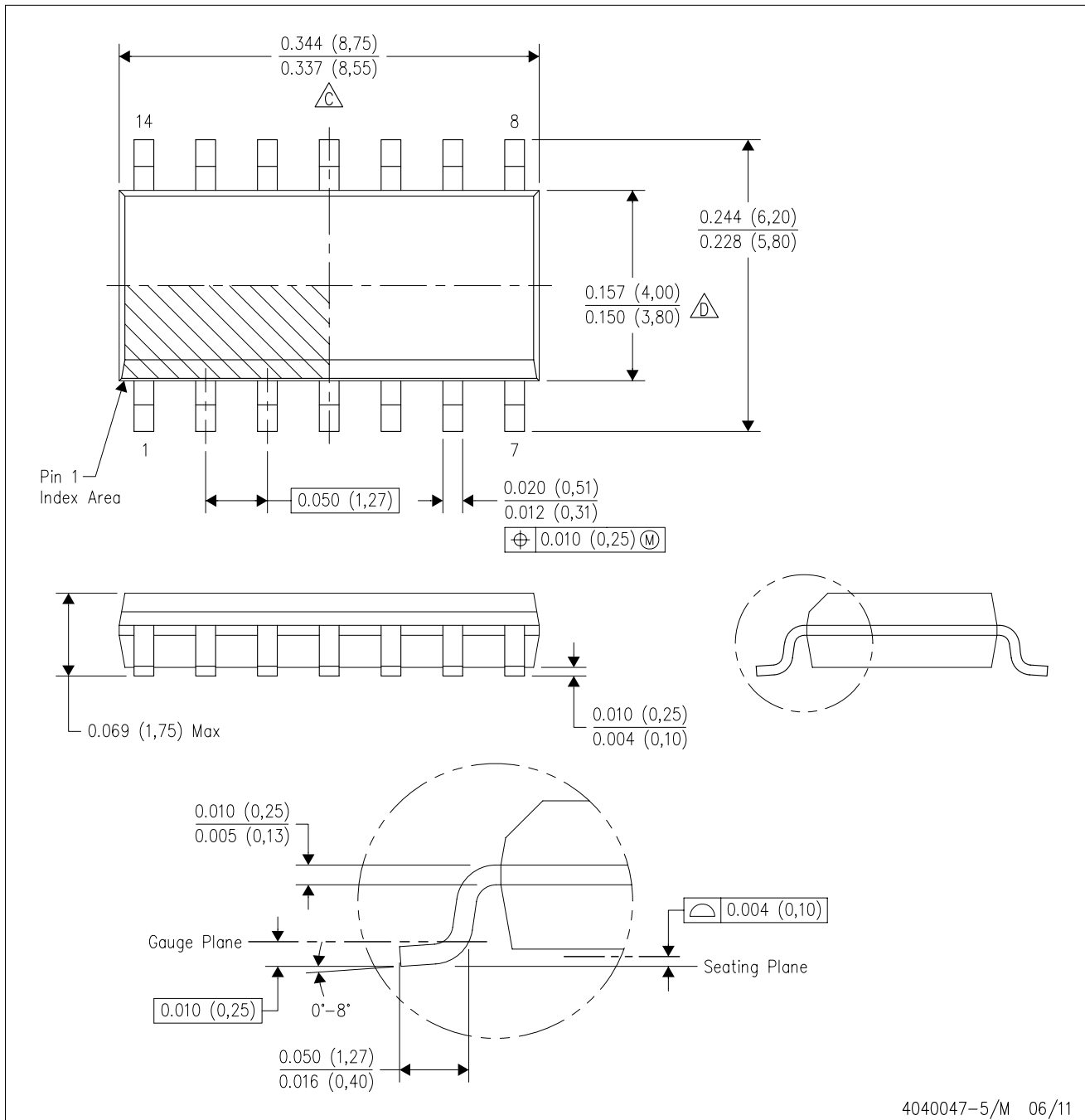
4214839/H 09/2023

NOTES: (continued)

8. Laser cutting apertures with trapezoidal walls and rounded corners may offer better paste release. IPC-7525 may have alternate design recommendations.
9. Board assembly site may have different recommendations for stencil design.

D (R-PDSO-G14)

PLASTIC SMALL OUTLINE

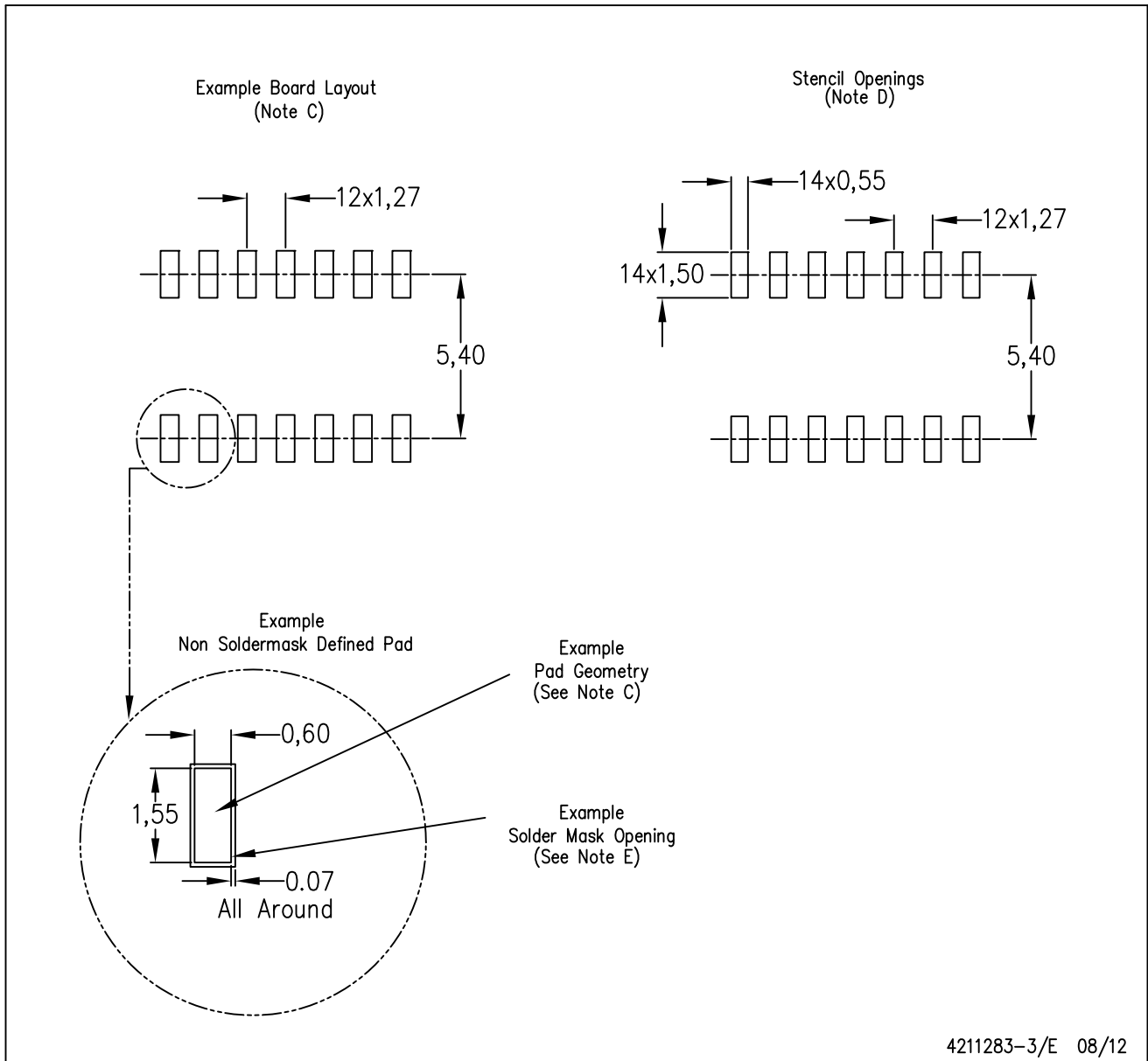


4040047-5/M 06/11

- NOTES:
- A. All linear dimensions are in inches (millimeters).
 - B. This drawing is subject to change without notice.
 - $\triangle C$ Body length does not include mold flash, protrusions, or gate burrs. Mold flash, protrusions, or gate burrs shall not exceed 0.006 (0,15) each side.
 - $\triangle D$ Body width does not include interlead flash. Interlead flash shall not exceed 0.017 (0,43) each side.
 - E. Reference JEDEC MS-012 variation AB.

D (R-PDSO-G14)

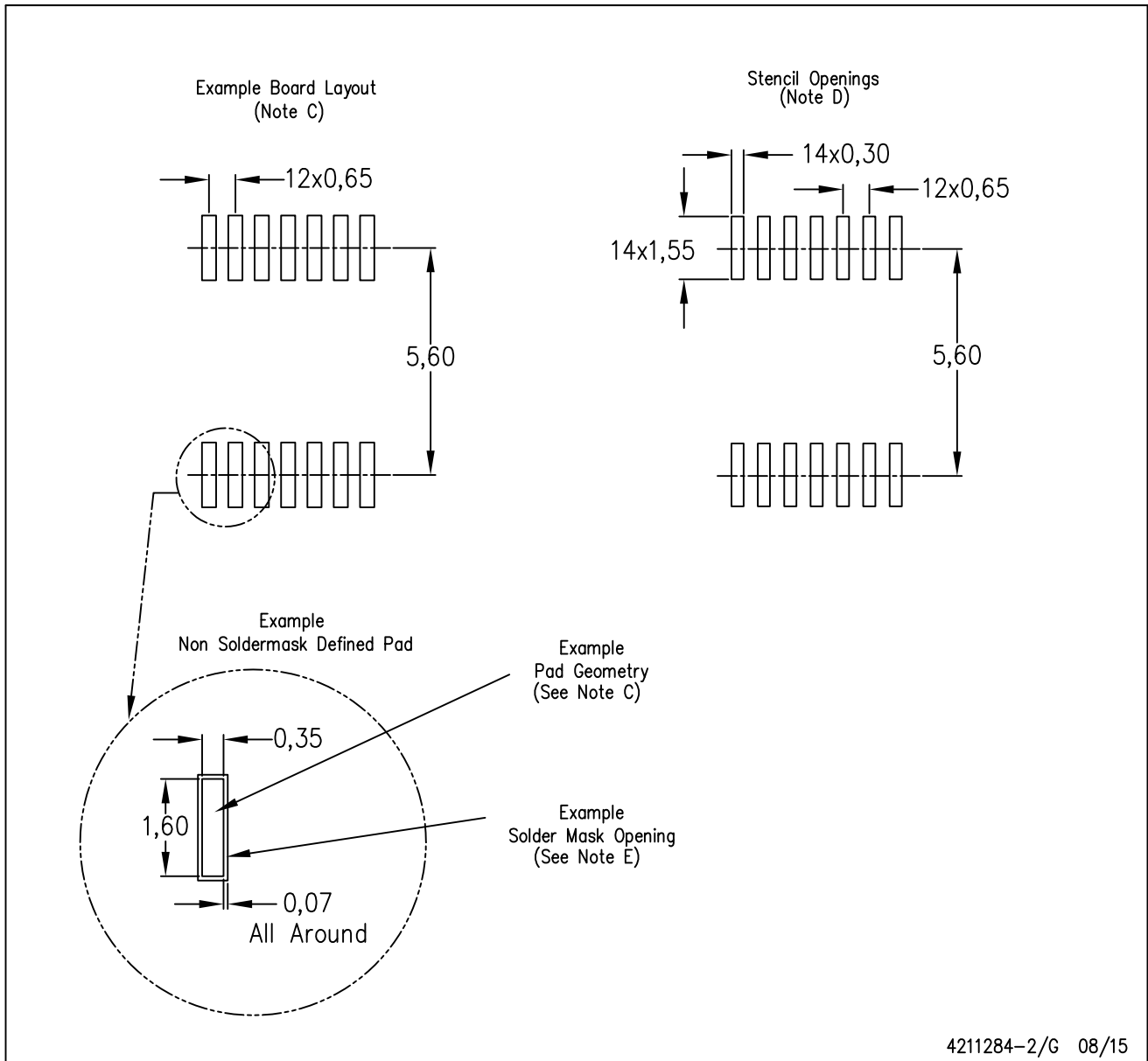
PLASTIC SMALL OUTLINE



- NOTES:
- All linear dimensions are in millimeters.
 - This drawing is subject to change without notice.
 - Publication IPC-7351 is recommended for alternate designs.
 - Laser cutting apertures with trapezoidal walls and also rounding corners will offer better paste release. Customers should contact their board assembly site for stencil design recommendations. Refer to IPC-7525 for other stencil recommendations.
 - Customers should contact their board fabrication site for solder mask tolerances between and around signal pads.

PW (R-PDSO-G14)

PLASTIC SMALL OUTLINE

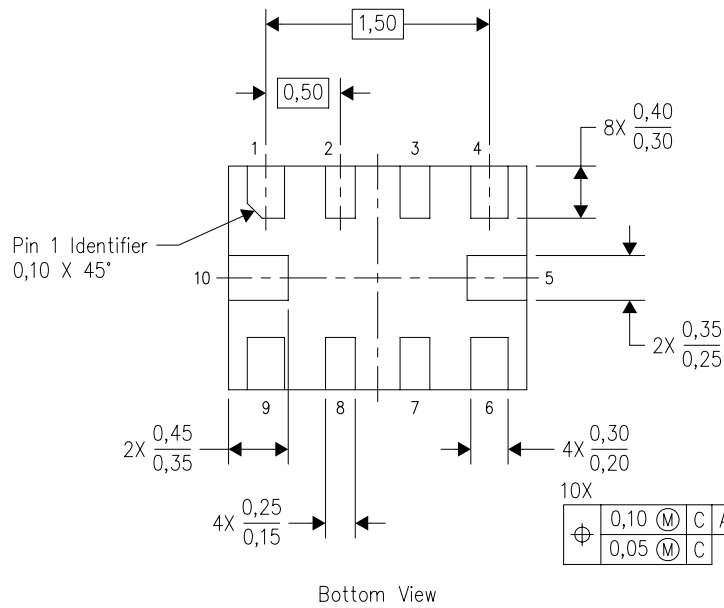
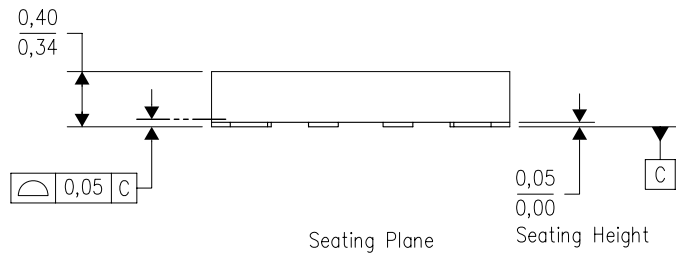
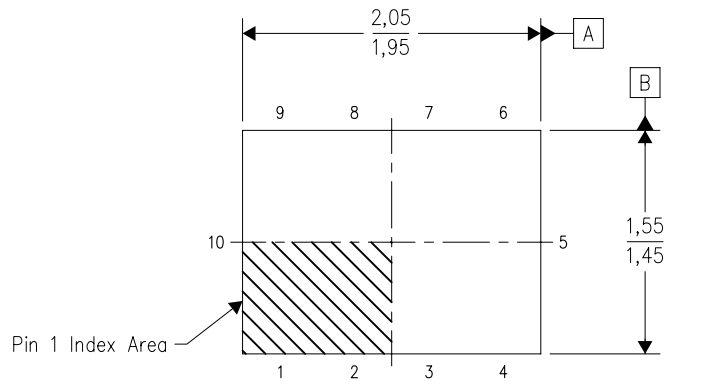


4211284-2/G 08/15

- NOTES:
- All linear dimensions are in millimeters.
 - This drawing is subject to change without notice.
 - Publication IPC-7351 is recommended for alternate designs.
 - Laser cutting apertures with trapezoidal walls and also rounding corners will offer better paste release. Customers should contact their board assembly site for stencil design recommendations. Refer to IPC-7525 for other stencil recommendations.
 - Customers should contact their board fabrication site for solder mask tolerances between and around signal pads.

RUG (R-PQFP-N10)

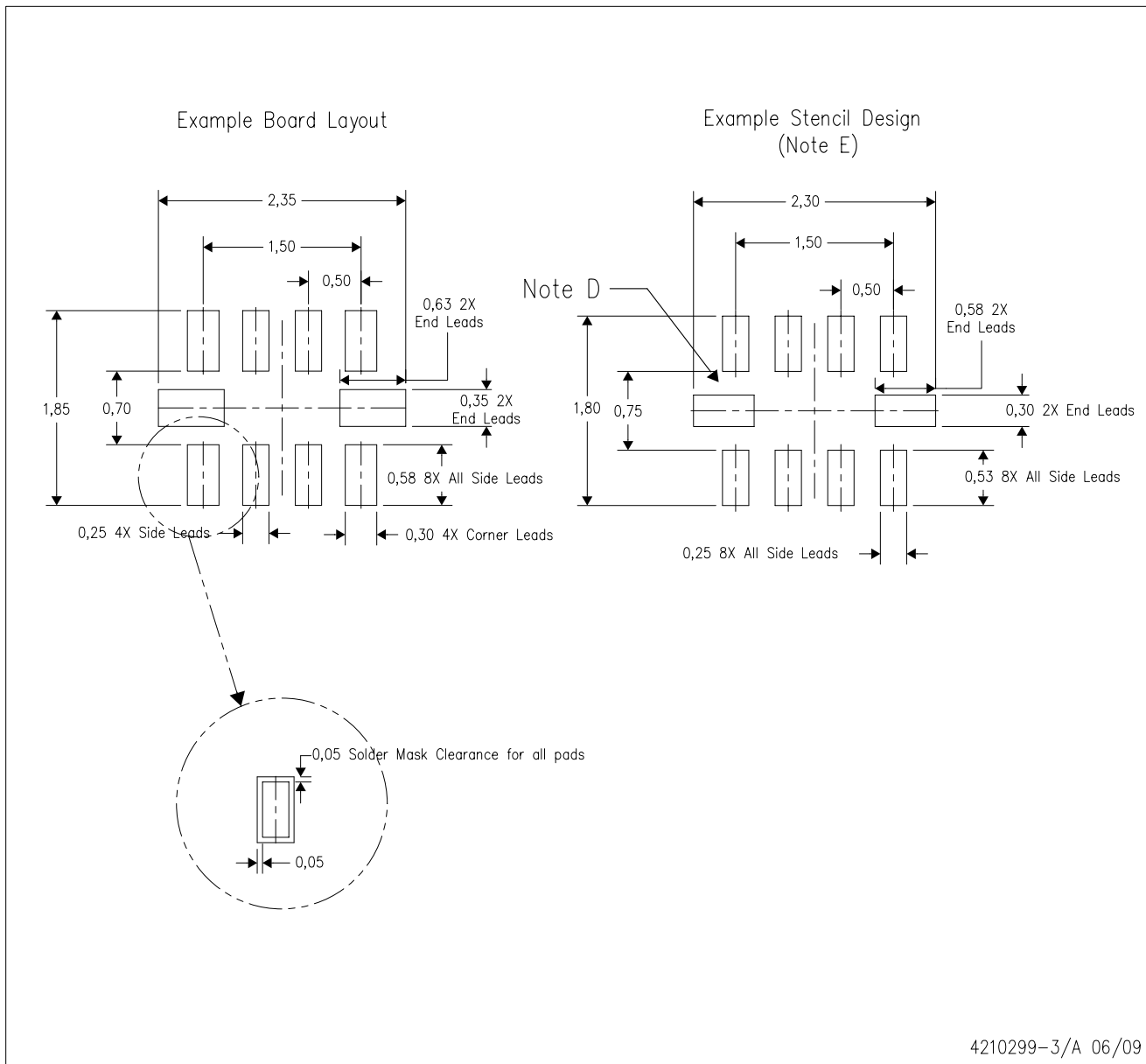
PLASTIC QUAD FLATPACK



4208528-3/B 04/2008

- NOTES:
- A. All linear dimensions are in millimeters. Dimensioning and tolerancing per ASME Y14.5M-1994.
 - B. This drawing is subject to change without notice.
 - C. QFN (Quad Flatpack No-Lead) package configuration.
 - D. This package complies to JEDEC MO-288 variation X2EFD.

RUG (R-PQFP-N10)



4210299-3/A 06/09

- NOTES:
- A. All linear dimensions are in millimeters.
 - B. This drawing is subject to change without notice.
 - C. Publication IPC-7351 is recommended for alternate designs.
 - D. Customers should contact their board fabrication site for minimum solder mask web tolerances between signal pads.
 - E. Maximum stencil thickness 0,127 mm (5 mils). All linear dimensions are in millimeters.
 - F. Laser cutting apertures with trapezoidal walls and also rounding corners will offer better paste release. Customers should contact their board assembly site for stencil design recommendations. Refer to IPC 7525 for stencil design considerations.
 - G. Side aperture dimensions over-print land for acceptable area ratio > 0.66. Customer may reduce side aperture dimensions if stencil manufacturing process allows for sufficient release at smaller opening.

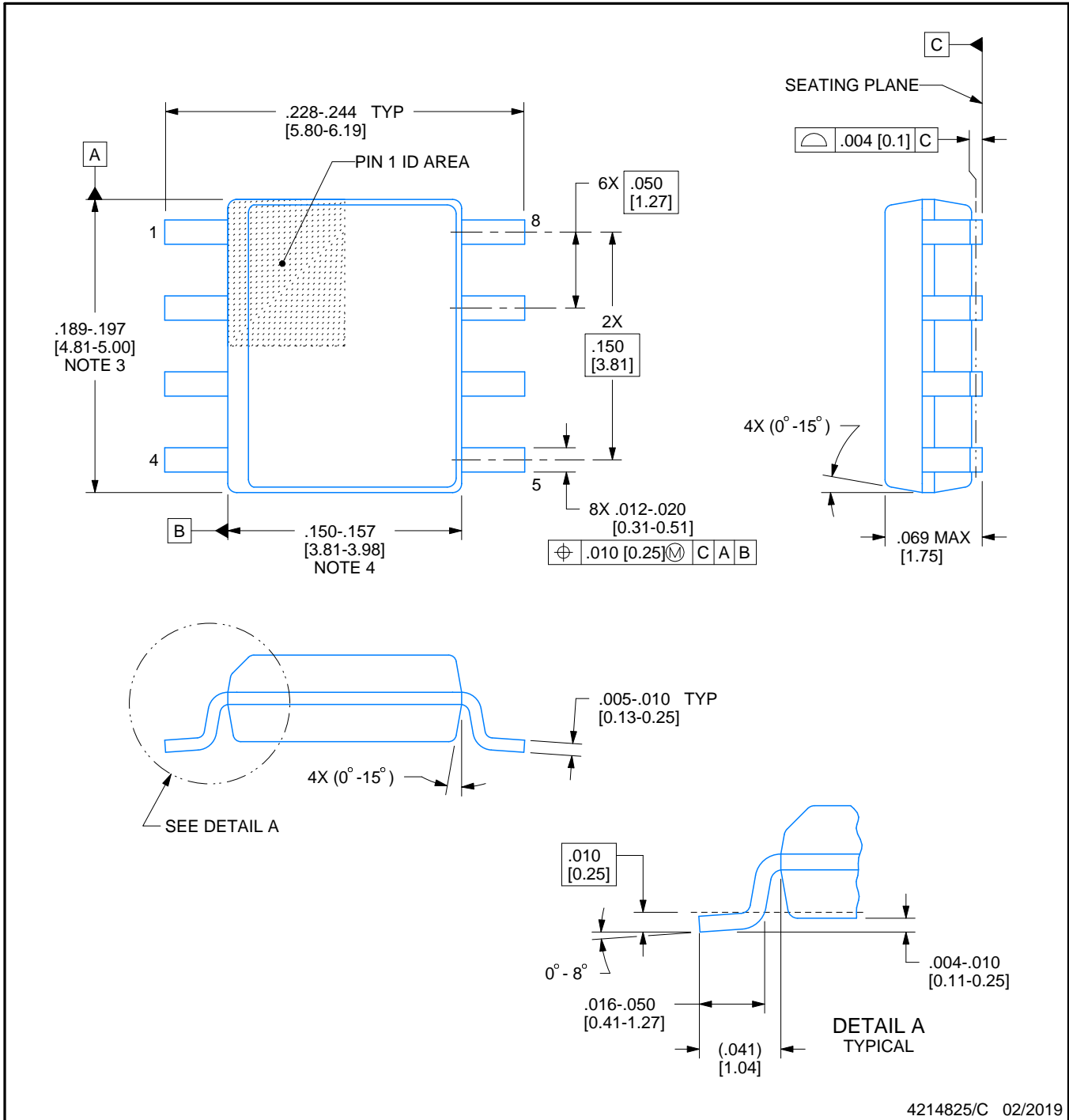


D0008A

PACKAGE OUTLINE

SOIC - 1.75 mm max height

SMALL OUTLINE INTEGRATED CIRCUIT



4214825/C 02/2019

NOTES:

- Linear dimensions are in inches [millimeters]. Dimensions in parenthesis are for reference only. Controlling dimensions are in inches. Dimensioning and tolerancing per ASME Y14.5M.
- This drawing is subject to change without notice.
- This dimension does not include mold flash, protrusions, or gate burrs. Mold flash, protrusions, or gate burrs shall not exceed $.006$ [0.15] per side.
- This dimension does not include interlead flash.
- Reference JEDEC registration MS-012, variation AA.

EXAMPLE BOARD LAYOUT

D0008A

SOIC - 1.75 mm max height

SMALL OUTLINE INTEGRATED CIRCUIT



LAND PATTERN EXAMPLE
EXPOSED METAL SHOWN
SCALE:8X



SOLDER MASK DETAILS

4214825/C 02/2019

NOTES: (continued)

- 6. Publication IPC-7351 may have alternate designs.
- 7. Solder mask tolerances between and around signal pads can vary based on board fabrication site.

EXAMPLE STENCIL DESIGN

D0008A

SOIC - 1.75 mm max height

SMALL OUTLINE INTEGRATED CIRCUIT



SOLDER PASTE EXAMPLE
BASED ON .005 INCH [0.125 MM] THICK STENCIL
SCALE:8X

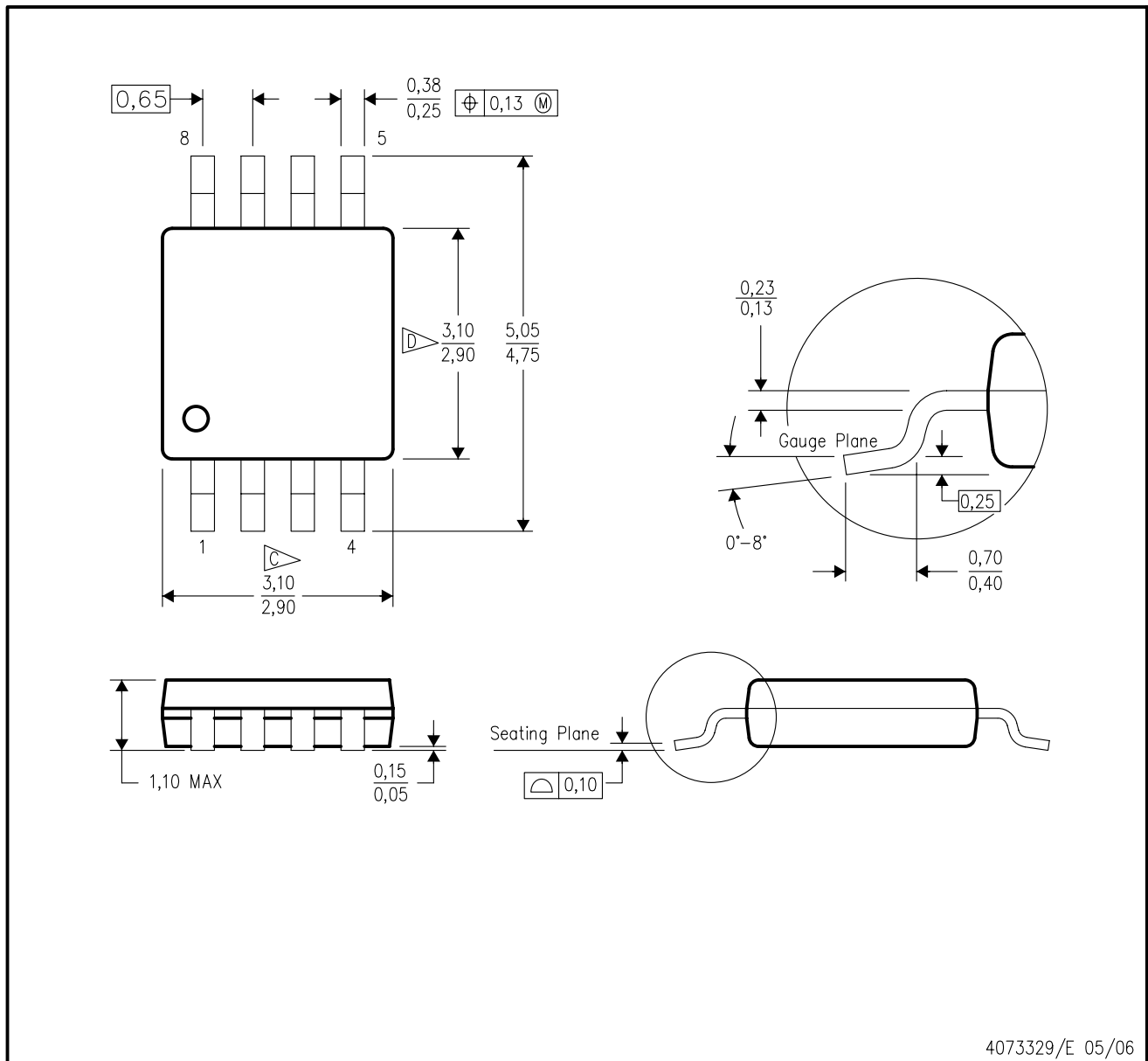
4214825/C 02/2019

NOTES: (continued)

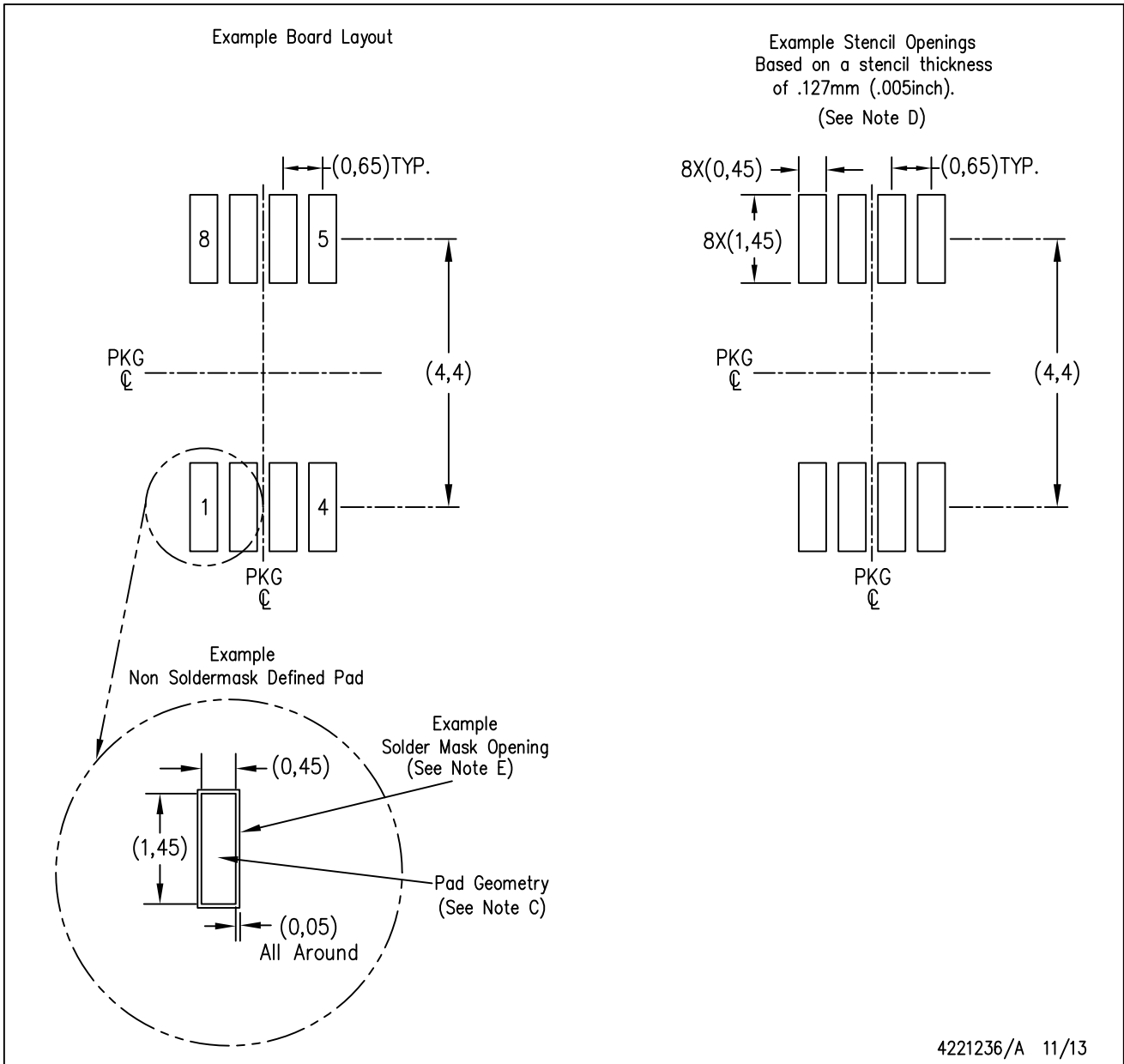
8. Laser cutting apertures with trapezoidal walls and rounded corners may offer better paste release. IPC-7525 may have alternate design recommendations.
9. Board assembly site may have different recommendations for stencil design.

DGK (S-PDSO-G8)

PLASTIC SMALL-OUTLINE PACKAGE



- NOTES:
- A. All linear dimensions are in millimeters.
 - B. This drawing is subject to change without notice.
 - C. Body length does not include mold flash, protrusions, or gate burrs. Mold flash, protrusions, or gate burrs shall not exceed 0.15 per end.
 - D. Body width does not include interlead flash. Interlead flash shall not exceed 0.50 per side.
 - E. Falls within JEDEC MO-187 variation AA, except interlead flash.



- NOTES:
- A. All linear dimensions are in millimeters.
 - B. This drawing is subject to change without notice.
 - C. Publication IPC-7351 is recommended for alternate designs.
 - D. Laser cutting apertures with trapezoidal walls and also rounding corners will offer better paste release. Customers should contact their board assembly site for stencil design recommendations. Refer to IPC-7525 for other stencil recommendations.
 - E. Customers should contact their board fabrication site for solder mask tolerances between and around signal pads.

GENERIC PACKAGE VIEW

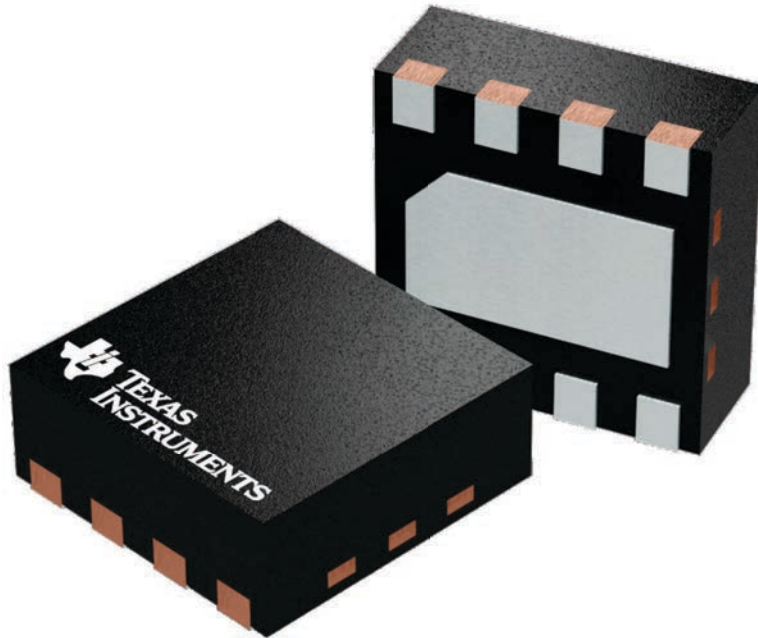
DSG 8

WSON - 0.8 mm max height

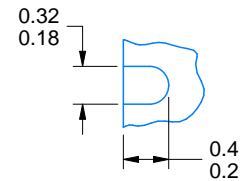
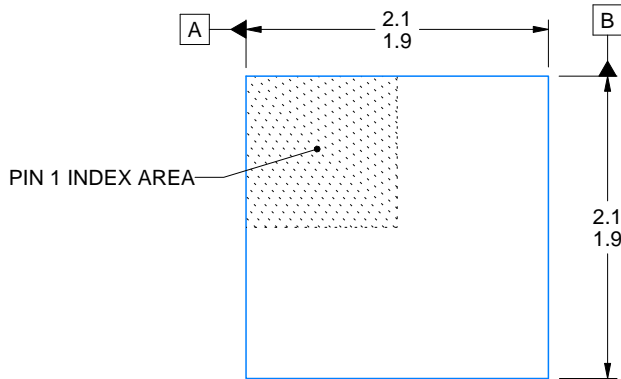
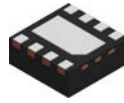
2 x 2, 0.5 mm pitch

PLASTIC SMALL OUTLINE - NO LEAD

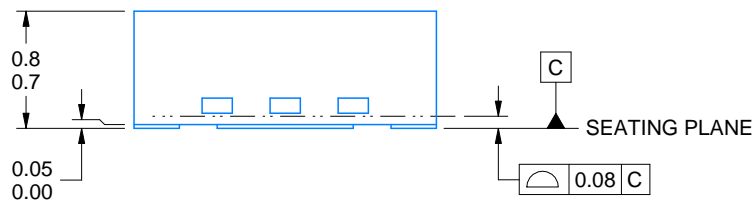
This image is a representation of the package family, actual package may vary.
Refer to the product data sheet for package details.



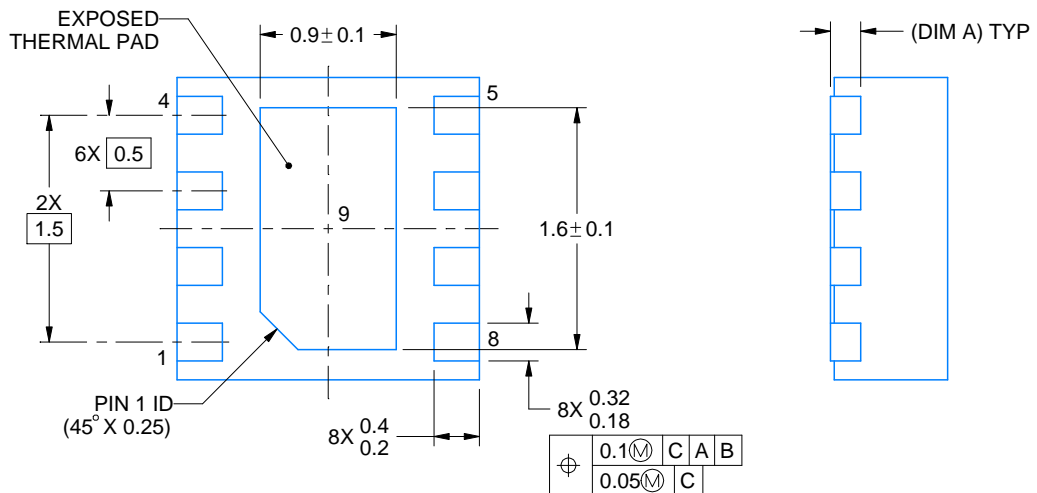
4224783/A



ALTERNATIVE TERMINAL SHAPE TYPICAL



SIDE WALL METAL THICKNESS DIM A	
OPTION 1	OPTION 2
0.1	0.2



4218900/E 08/2022

NOTES:

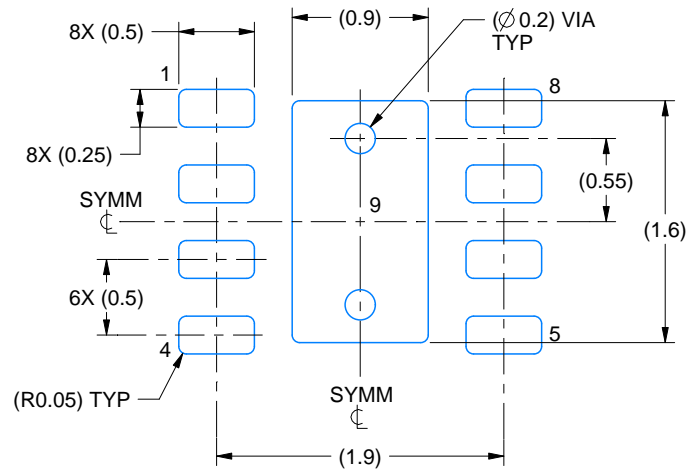
1. All linear dimensions are in millimeters. Any dimensions in parenthesis are for reference only. Dimensioning and tolerancing per ASME Y14.5M.
2. This drawing is subject to change without notice.
3. The package thermal pad must be soldered to the printed circuit board for thermal and mechanical performance.

EXAMPLE BOARD LAYOUT

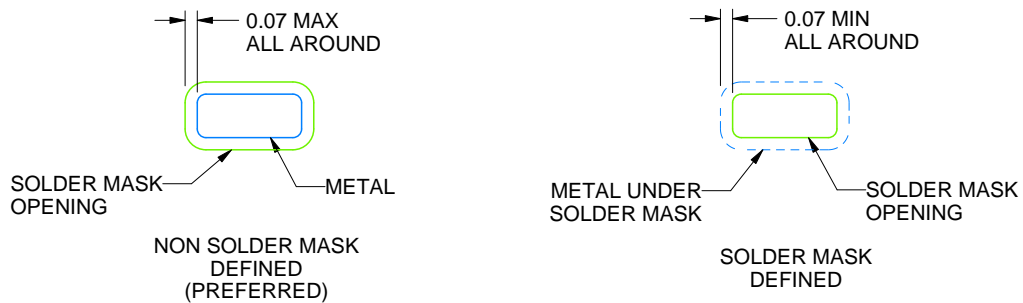
DSG0008A

WSON - 0.8 mm max height

PLASTIC SMALL OUTLINE - NO LEAD



LAND PATTERN EXAMPLE
SCALE:20X



SOLDER MASK DETAILS

4218900/E 08/2022

NOTES: (continued)

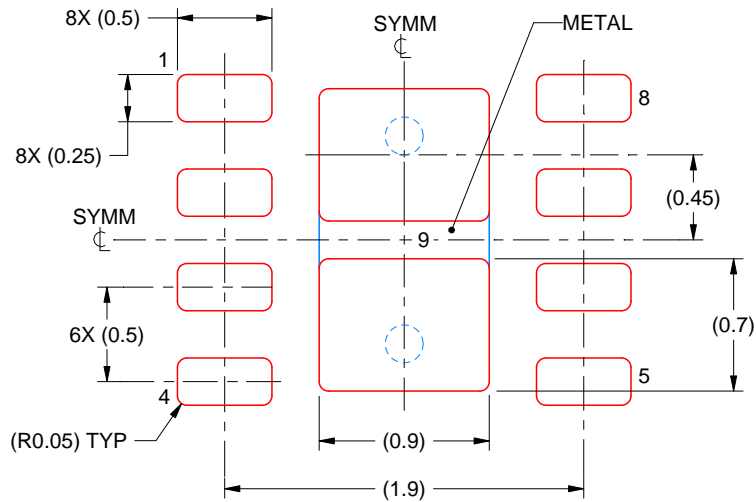
4. This package is designed to be soldered to a thermal pad on the board. For more information, see Texas Instruments literature number SLUA271 (www.ti.com/lit/slua271).
5. Vias are optional depending on application, refer to device data sheet. If any vias are implemented, refer to their locations shown on this view. It is recommended that vias under paste be filled, plugged or tented.

EXAMPLE STENCIL DESIGN

DSG0008A

WSON - 0.8 mm max height

PLASTIC SMALL OUTLINE - NO LEAD



SOLDER PASTE EXAMPLE
BASED ON 0.125 mm THICK STENCIL

EXPOSED PAD 9:
87% PRINTED SOLDER COVERAGE BY AREA UNDER PACKAGE
SCALE:25X

4218900/E 08/2022

NOTES: (continued)

6. Laser cutting apertures with trapezoidal walls and rounded corners may offer better paste release. IPC-7525 may have alternate design recommendations.

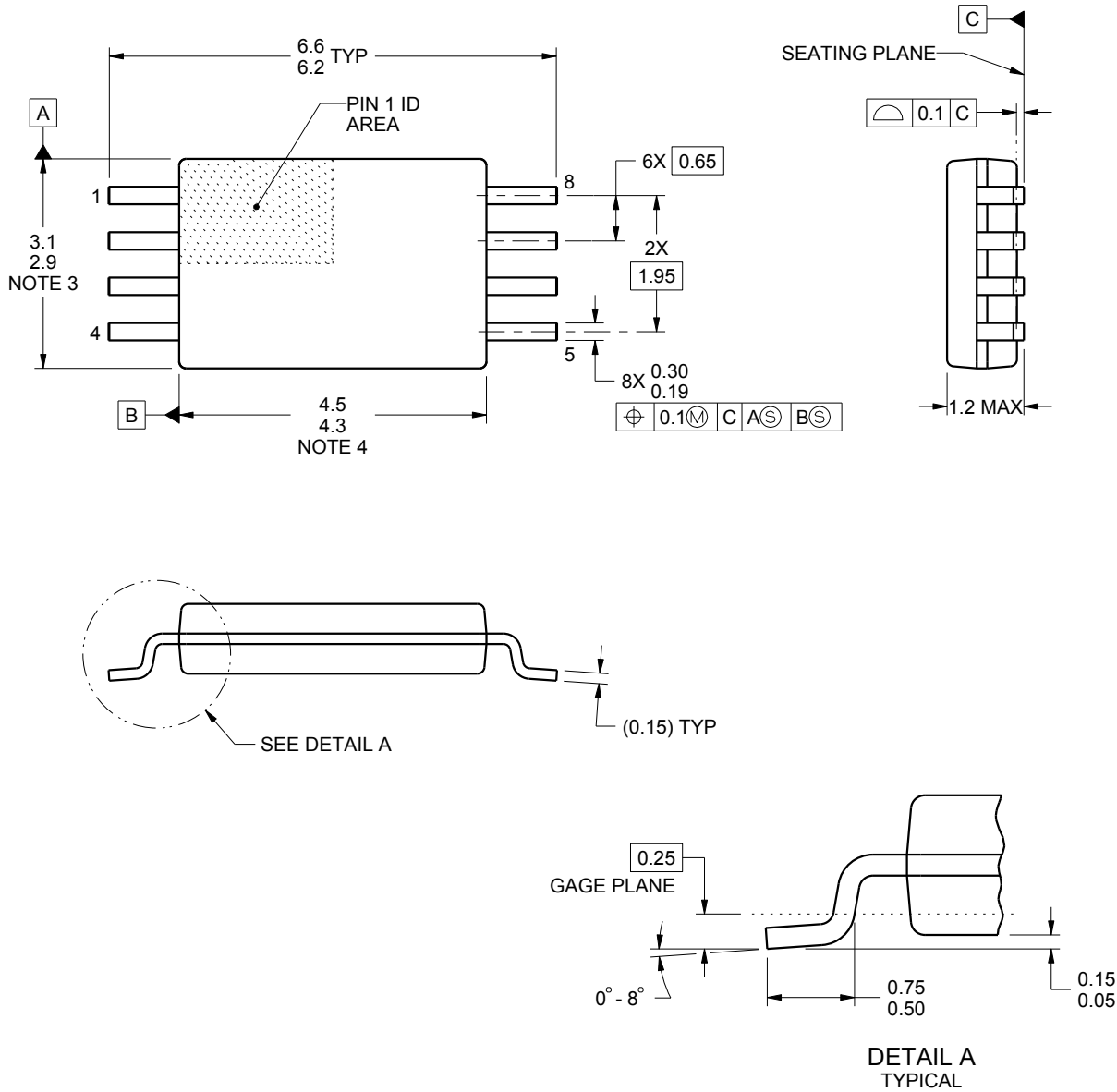
PW0008A



PACKAGE OUTLINE

TSSOP - 1.2 mm max height

SMALL OUTLINE PACKAGE



4221848/A 02/2015

NOTES:

1. All linear dimensions are in millimeters. Any dimensions in parenthesis are for reference only. Dimensioning and tolerancing per ASME Y14.5M.
2. This drawing is subject to change without notice.
3. This dimension does not include mold flash, protrusions, or gate burrs. Mold flash, protrusions, or gate burrs shall not exceed 0.15 mm per side.
4. This dimension does not include interlead flash. Interlead flash shall not exceed 0.25 mm per side.
5. Reference JEDEC registration MO-153, variation AA.

EXAMPLE BOARD LAYOUT

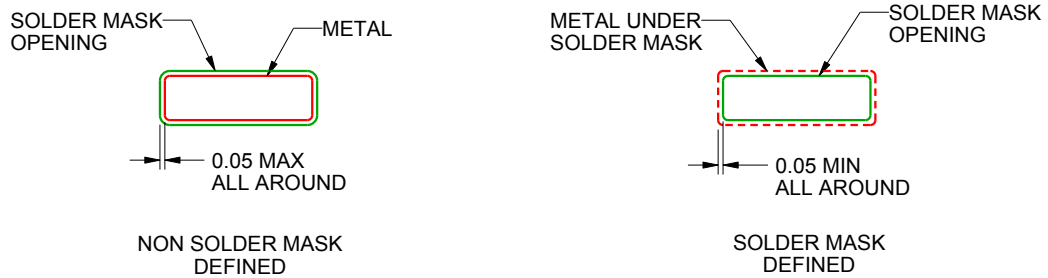
PW0008A

TSSOP - 1.2 mm max height

SMALL OUTLINE PACKAGE



LAND PATTERN EXAMPLE
SCALE:10X



SOLDER MASK DETAILS
NOT TO SCALE

4221848/A 02/2015

NOTES: (continued)

- 6. Publication IPC-7351 may have alternate designs.
- 7. Solder mask tolerances between and around signal pads can vary based on board fabrication site.

EXAMPLE STENCIL DESIGN

PW0008A

TSSOP - 1.2 mm max height

SMALL OUTLINE PACKAGE

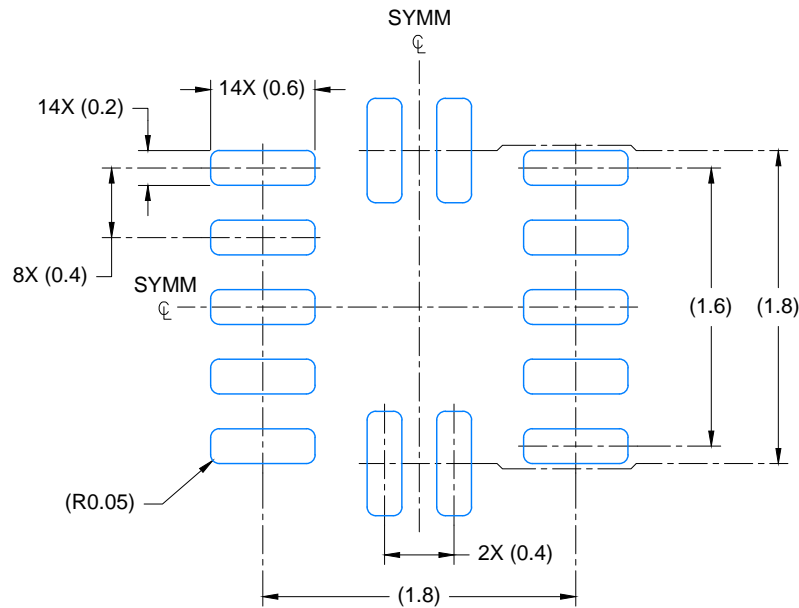


SOLDER PASTE EXAMPLE
BASED ON 0.125 mm THICK STENCIL
SCALE:10X

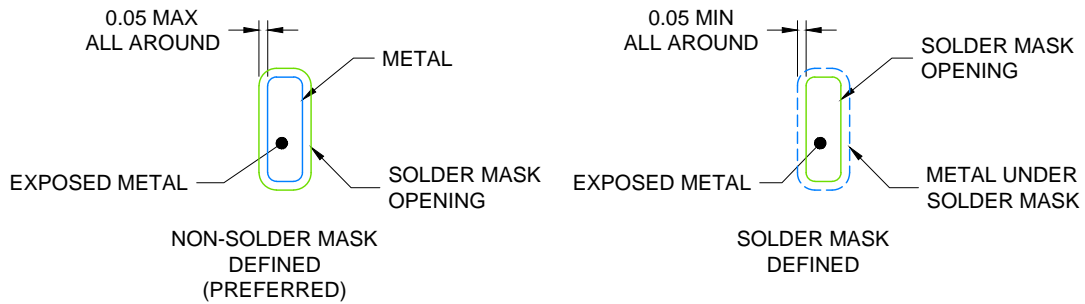
4221848/A 02/2015

NOTES: (continued)

8. Laser cutting apertures with trapezoidal walls and rounded corners may offer better paste release. IPC-7525 may have alternate design recommendations.
9. Board assembly site may have different recommendations for stencil design.



LAND PATTERN EXAMPLE
EXPOSED METAL SHOWN
SCALE: 23X



SOLDER MASK DETAILS

4220584/A 05/2019

NOTES: (continued)

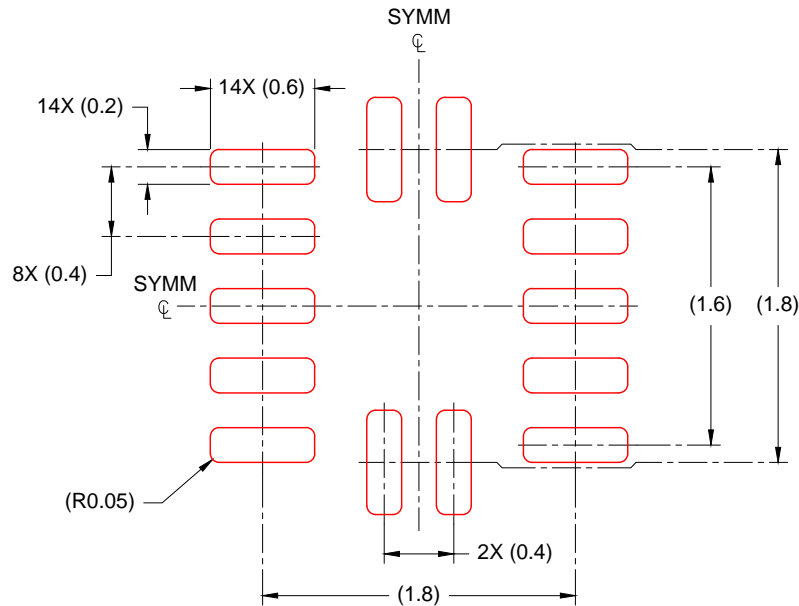
- For more information, see Texas Instruments literature number SLUA271 (www.ti.com/lit/slua271).

EXAMPLE STENCIL DESIGN

RUC0014A

X2QFN - 0.4 mm max height

PLASTIC QUAD FLAT PACK- NO LEAD



SOLDER PASTE EXAMPLE
BASED ON 0.100mm THICK STENCIL
SCALE: 23X

4220584/A 05/2019

NOTES: (continued)

4. Laser cutting apertures with trapezoidal walls and rounded corners may offer better paste release. IPC-7525 may have alternate design recommendations.

IMPORTANT NOTICE AND DISCLAIMER

TI PROVIDES TECHNICAL AND RELIABILITY DATA (INCLUDING DATA SHEETS), DESIGN RESOURCES (INCLUDING REFERENCE DESIGNS), APPLICATION OR OTHER DESIGN ADVICE, WEB TOOLS, SAFETY INFORMATION, AND OTHER RESOURCES "AS IS" AND WITH ALL FAULTS, AND DISCLAIMS ALL WARRANTIES, EXPRESS AND IMPLIED, INCLUDING WITHOUT LIMITATION ANY IMPLIED WARRANTIES OF MERCHANTABILITY, FITNESS FOR A PARTICULAR PURPOSE OR NON-INFRINGEMENT OF THIRD PARTY INTELLECTUAL PROPERTY RIGHTS.

These resources are intended for skilled developers designing with TI products. You are solely responsible for (1) selecting the appropriate TI products for your application, (2) designing, validating and testing your application, and (3) ensuring your application meets applicable standards, and any other safety, security, regulatory or other requirements.

These resources are subject to change without notice. TI grants you permission to use these resources only for development of an application that uses the TI products described in the resource. Other reproduction and display of these resources is prohibited. No license is granted to any other TI intellectual property right or to any third party intellectual property right. TI disclaims responsibility for, and you will fully indemnify TI and its representatives against, any claims, damages, costs, losses, and liabilities arising out of your use of these resources.

TI's products are provided subject to [TI's Terms of Sale](#) or other applicable terms available either on [ti.com](https://www.ti.com) or provided in conjunction with such TI products. TI's provision of these resources does not expand or otherwise alter TI's applicable warranties or warranty disclaimers for TI products.

TI objects to and rejects any additional or different terms you may have proposed.

Mailing Address: Texas Instruments, Post Office Box 655303, Dallas, Texas 75265
Copyright © 2023, Texas Instruments Incorporated