

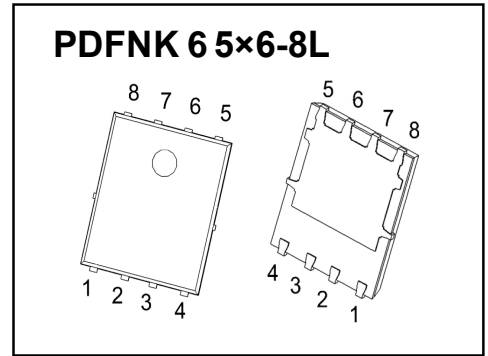

**PDFNWB5×6-8L Plastic-Encapsulate MOSFETS**

**CJAC80SN10 N-Channel Power MOSFET**

$V_{(BR)DSS}$	$R_{DS(on)TYP}$	$I_D$
100V	6.2mΩ@10V	80A
	8.8mΩ@4.5V	



**DESCRIPTION**

The CJAC80SN10 uses shielded gate trench technology and design to provide excellent  $R_{DS(ON)}$  with low gate charge. It can be used in a wide variety of applications

**FEATURE**

- Excellent package for good heat dissipation
- Ultra low gate charge
- Low reverse transfer capacitance
- Fast switching capability
- Avalanche energy specified

**APPLICATION**

- Power switching application

**MARKING**

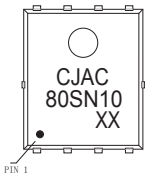

CJAC80SN10 = Part No.  
 Solid dot = Pin1 indicator.  
 XX = Code .

**EQUIVALENT CIRCUIT**

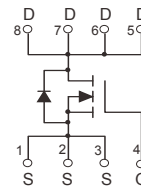

**MAXIMUM RATINGS (  $T_a=25^{\circ}C$  unless otherwise noted )**

Parameter	Symbol	Limit	Unit
Drain-Source Voltage	$V_{DS}$	100	V
Gate-Source Voltage	$V_{GS}$	±20	V
Continuous Drain Current	$I_D$ ①	80	A
Pulsed Drain Current	$I_{DM}$ ②	320	A
Single Pulsed Avalanche Energy	$E_{AS}$ ③	280	mJ
Power Dissipation	$P_D$ ①	100	W
Thermal Resistance from Junction to Ambient	$R_{\theta JA}$ ⑥	62.5	°CW
Thermal Resistance from Junction to Case	$R_{\theta JC}$ ①	1.25	°CW
Operating Junction and Storage Temperature Range	$T_J, T_{stg}$	-55~+150	°C

# MOSFET ELECTRICAL CHARACTERISTICS

$T_a=25^\circ\text{C}$  unless otherwise specified

Parameter	Symbol	Test Condition	Min	Typ	Max	Unit
<b>Off characteristics</b>						
Drain-source breakdown voltage	$V_{(BR)DSS}$	$V_{GS} = 0V, I_D = 250\mu A$	100			V
Zero gate voltage drain current	$I_{DSS}$	$V_{DS} = 80V, V_{GS} = 0V$	$T_J = 25^\circ\text{C}$		1.0	$\mu A$
			$T_J = 125^\circ\text{C}$		100	
Gate-body leakage current	$I_{GSS}$	$V_{DS} = 0V, V_{GS} = \pm 20V$			$\pm 100$	nA
<b>On characteristics</b> <sup>④</sup>						
Gate-threshold voltage	$V_{GS(th)}$	$V_{DS} = V_{GS}, I_D = 250\mu A$	1.0	1.8	2.5	V
Static drain-source on-state resistance	$R_{DS(on)}$	$V_{GS} = 10V, I_D = 20A$		6.2	8.5	m $\Omega$
		$V_{GS} = 4.5V, I_D = 15A$		8.8	10.5	m $\Omega$
<b>Dynamic characteristics</b> <sup>④ ⑤</sup>						
Input capacitance	$C_{iss}$	$V_{DS} = 50V, V_{GS} = 0V, f = 500KHz$		2200	4400	$\mu F$
Output capacitance	$C_{oss}$			420	840	
Reverse transfer capacitance	$C_{rss}$			6.3	12.5	
Gate resistance	$R_g$	$f = 1MHz$		2.9		$\Omega$
<b>Switching characteristics</b> <sup>④ ⑤</sup>						
Total gate charge	$Q_g$	$V_{GS} = 10V, V_{DS} = 50V, I_D = 20A$		46	92	nC
Gate-source charge	$Q_{gs}$			6.4	12	
Gate-drain charge	$Q_{gd}$			15.4	31	
Turn-on delay time	$t_{d(on)}$	$V_{DD} = 50V, I_D = 20A, V_{GS} = 10V, R_G = 3\Omega$		$\hat{I}$		ns
Turn-on rise time	$t_r$			$\hat{I}$		
Turn-off delay time	$t_{d(off)}$			$\hat{G}$		
Turn-off fall time	$t_f$			$\hat{I}$		
<b>Drain-Source Diode Characteristics</b>						
Drain-source diode forward voltage	$V_{SD}$ <sup>④</sup>	$V_{GS} = 0V, I_S = 10A$			1.2	V
Continuous drain-source diode forward current	$I_S$ <sup>①</sup>				80	A
Pulsed drain-source diode forward current	$I_{SM}$ <sup>②</sup>				320	A

Notes:

1.  $T_c = 25^\circ\text{C}$  Limited only by maximum temperature allowed.

2.  $P_w \leq 10\mu s$ , Duty cycle  $\leq 1\%$ .

3. EAS condition:  $V_{DD} = 50V, V_{GS} = 10V, L = 0.5mH, R_g = 25\Omega$  Starting  $T_J = 25^\circ\text{C}$ .

4. Pulse Test : Pulse Width  $\leq 300\mu s$ , duty cycle  $\leq 2\%$ .

5. Guaranteed by design, not subject to production.

6. The value of  $R_{\theta JA}$  is measured with the device mounted on 1 in 2 FR-4 board with 2oz. Copper, in a still air environment with  $T_a = 25^\circ\text{C}$ .

# Typical Characteristics

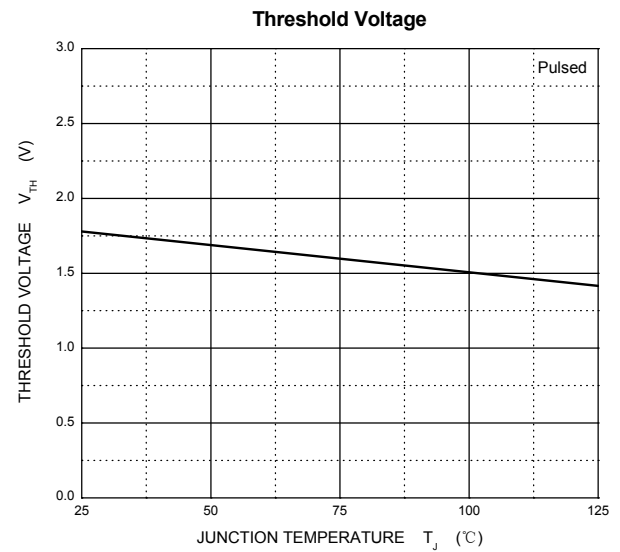
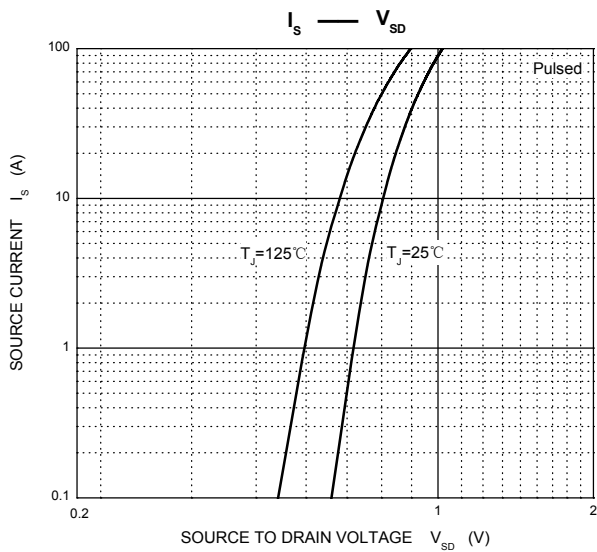
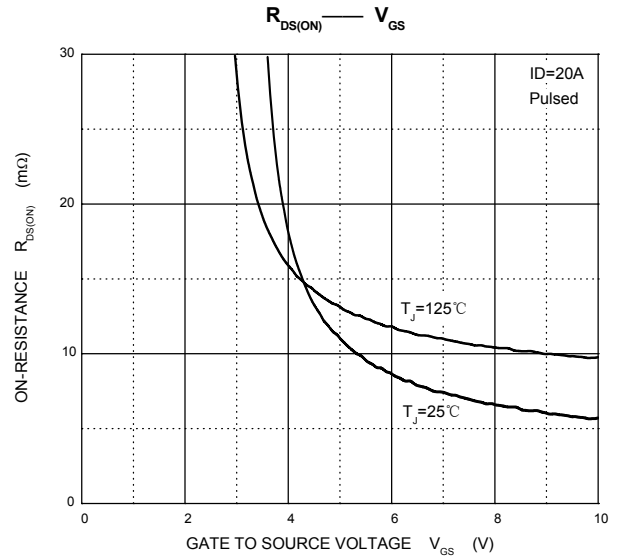
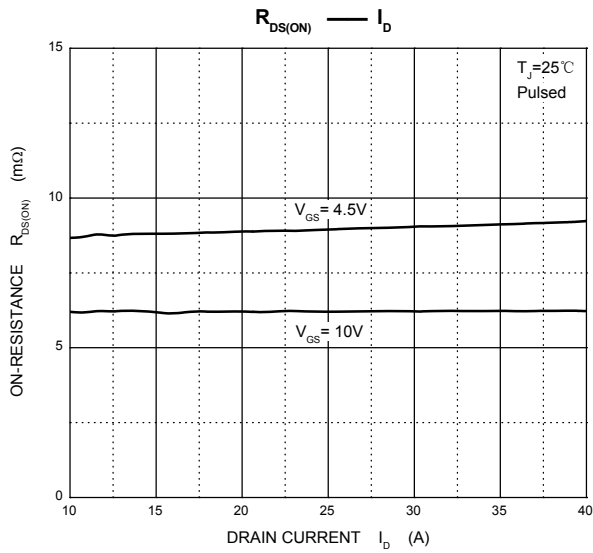
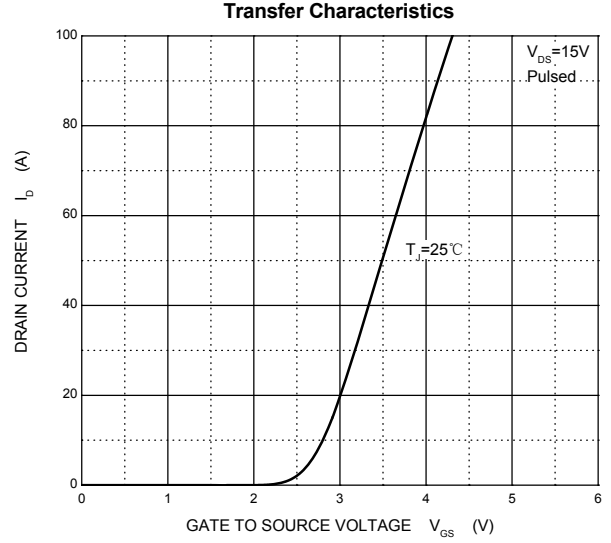
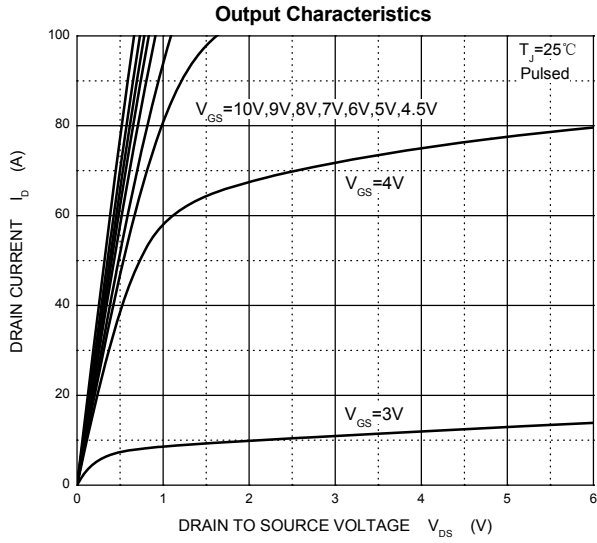

# Typical Characteristics

### Capacitances

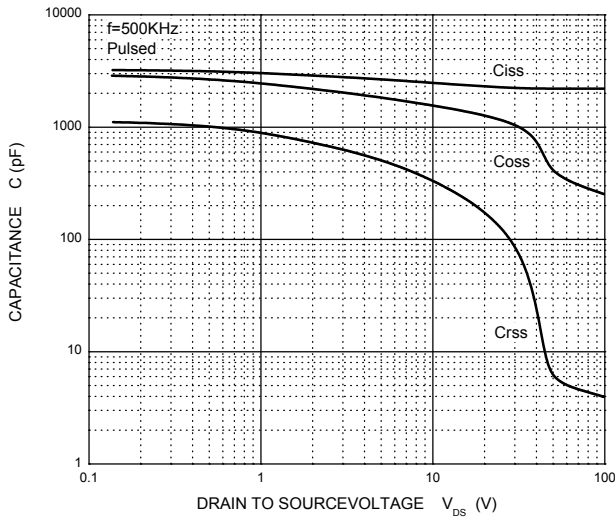

### Gate Charge

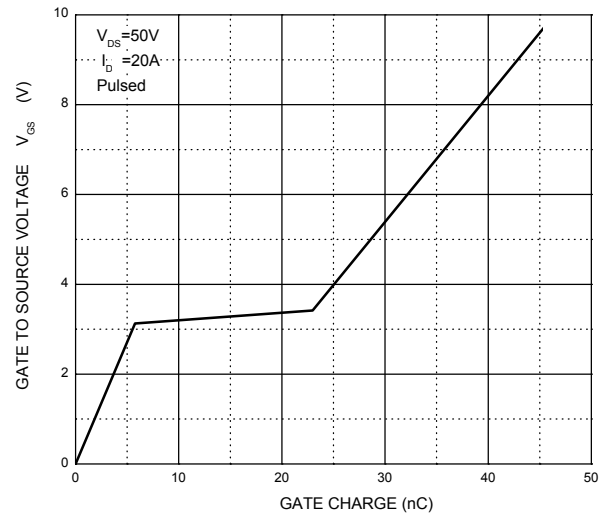

### NORMALIZED MAXIMUM TRANSIENT THERMAL IMPEDANCE

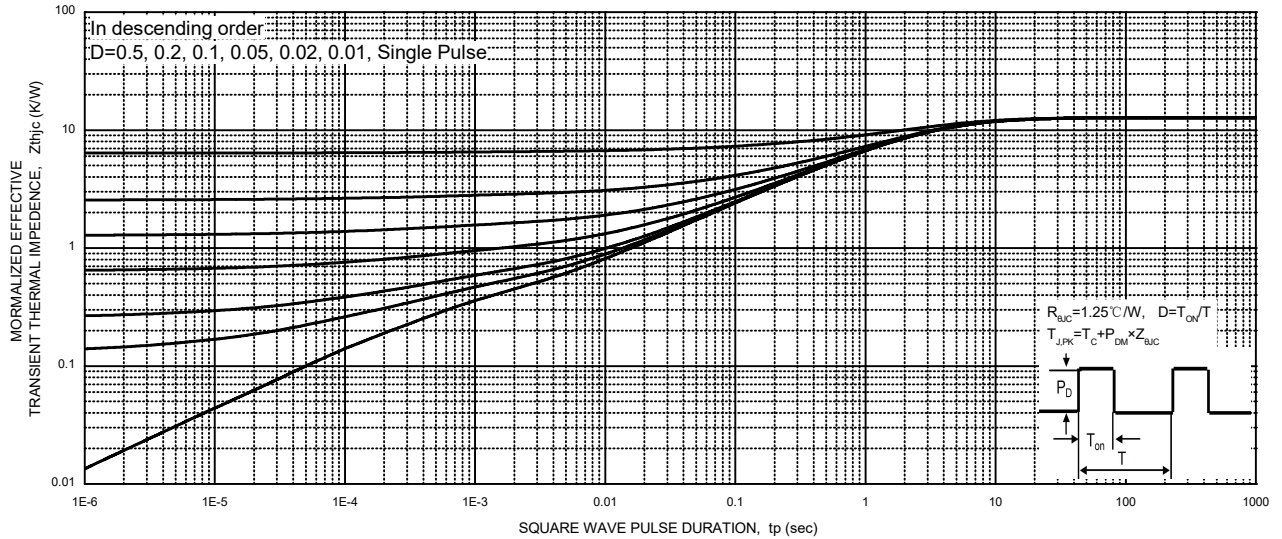

### MAXIMUM FORWARD BIASED SAFE OPERATING AREA

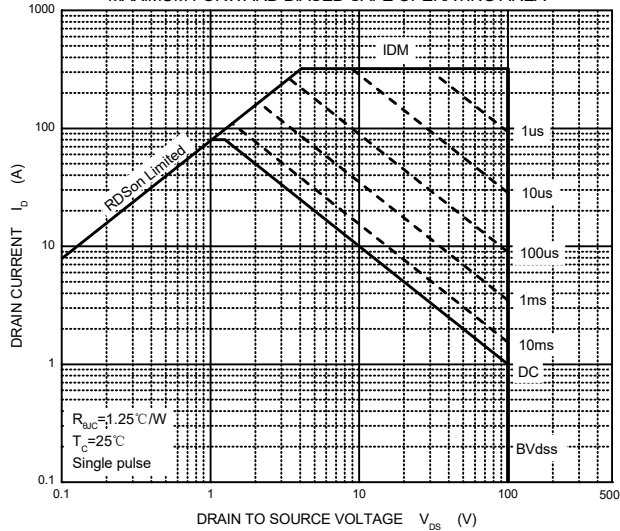

## PDFNWB5x6-8L Package Outline Dimensions

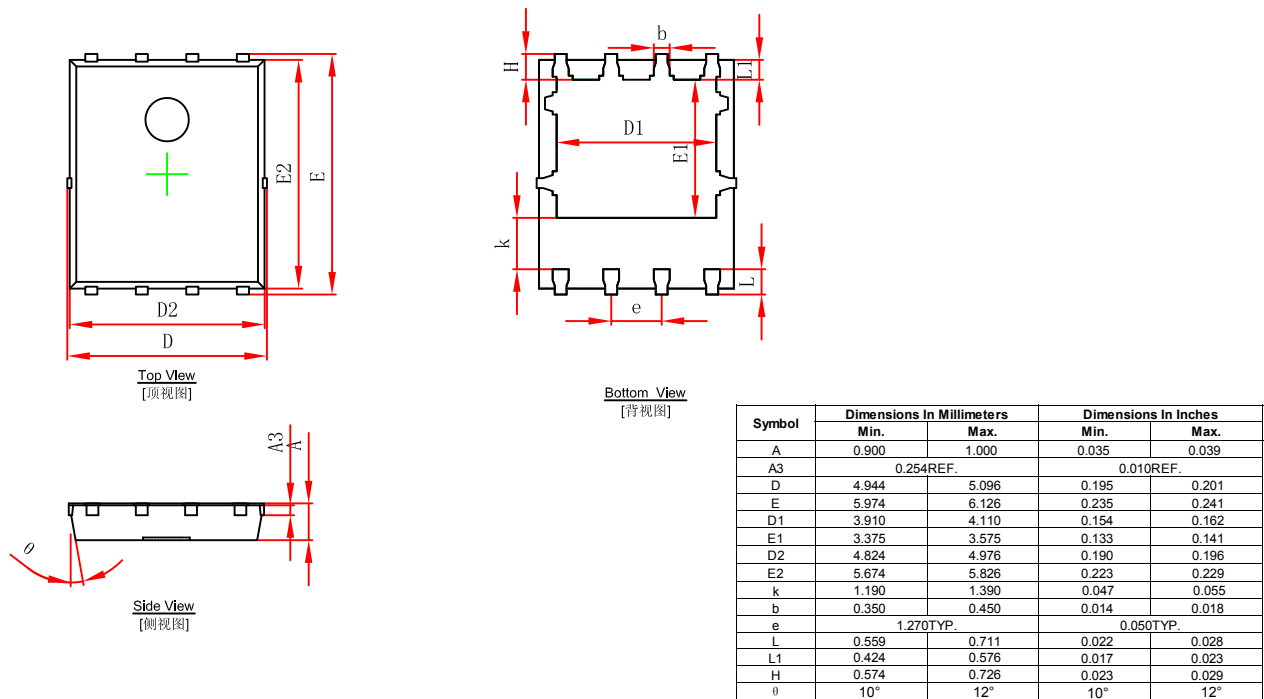

## PDFNWB5x6-8L Suggested Pad Layout

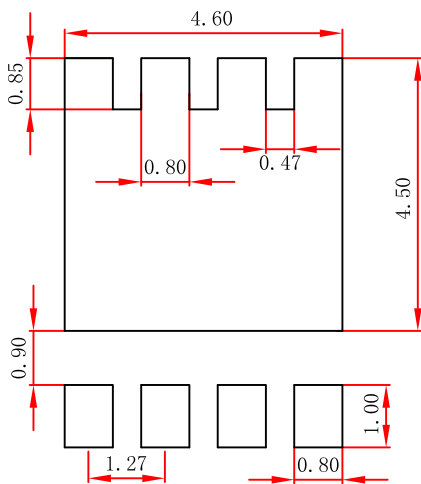

Note:

1. Controlling dimension: in millimeters.
2. General tolerance:  $\pm 0.05$  mm.
3. The pad layout is for reference purposes only.

### NOTICE

JCET reserve the right to make modifications, enhancements, improvements, corrections or other changes without further notice to any product herein. JCET does not assume any liability arising out of the application or use of any product described herein.

# PDFNWB5×6 Tape and Reel

## PDFNWB5×6-8L Embossed Carrier Tape

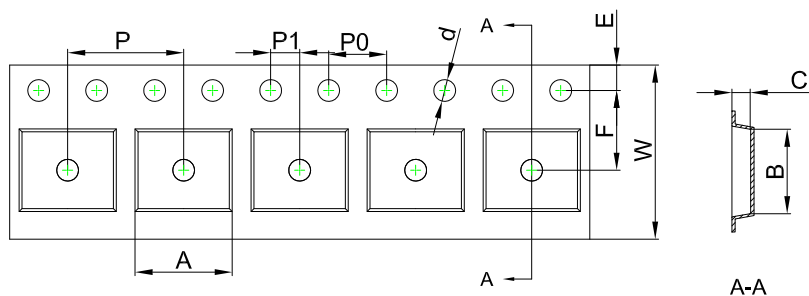

**Packaging Description:**  
**PDFNWB5×6-8L** parts are shipped in tape. The carrier tape is made from a dissipative (carbon filled) polycarbonate resin. The cover tape is a multilayer film (Heat Activated Adhesive in nature) primarily composed of polyester film, adhesive layer, sealant, and anti-static sprayed agent. These reeled parts in standard option are shipped with 5,000 units per 13" or 33.0 cm diameter reel. The reels are clear in color and is made of polystyrene plastic (anti-static coated).

Dimensions are in millimeter										
Pkg type	A	B	C	d	E	F	P0	P	P1	W
PDFNWB5×6-8L	6.30	5.30	1.10	Ø1.50	1.75	5.50	4.00	8.00	2.00	12.00

## PDFNWB5×6-8L Tape Leader and Trailer

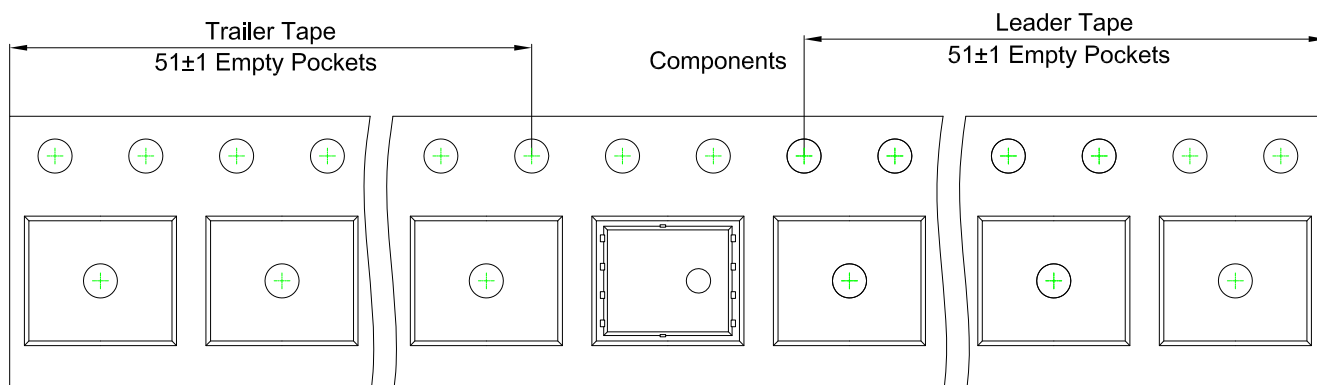

## PDFNWB5×6-8L Reel

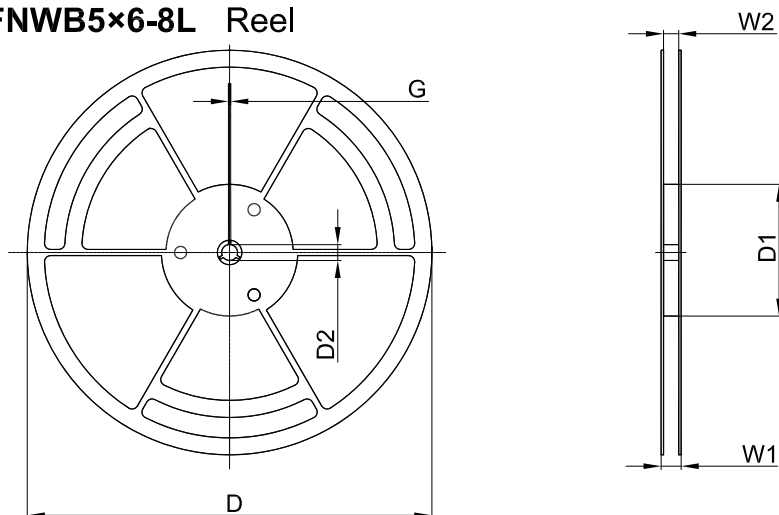

Dimensions are in millimeter						
Reel Option	D	D1	D2	G	W1	W2
13"Dia	Ø330.00	100.00	13.00	1.90	17.60	12.40

REEL	Reel Size	Box	Box Size(mm)	Carton	Carton Size(mm)
5,000 pcs	13 inch	5,000 pcs	340×336×29	50,000 pcs	353×346×365